



# ADDENDA

**ANSI/ASHRAE Addendum a to  
ANSI/ASHRAE Standard 140-2011**

# **Standard Method of Test for the Evaluation of Building Energy Analysis Computer Programs**

Approved by the ASHRAE Standards Committee on June 28, 2014; by the ASHRAE Board of Directors on July 2, 2014; and by the American National Standards Institute on July 3, 2014.

This addendum was approved by a Standing Standard Project Committee (SSPC) for which the Standards Committee has established a documented program for regular publication of addenda or revisions, including procedures for timely, documented, consensus action on requests for change to any part of the standard. The change submittal form, instructions, and deadlines may be obtained in electronic form from the ASHRAE website ([www.ashrae.org](http://www.ashrae.org)) or in paper form from the Manager of Standards.

The latest edition of an ASHRAE Standard may be purchased on the ASHRAE website ([www.ashrae.org](http://www.ashrae.org)) or from ASHRAE Customer Service, 1791 Tullie Circle, NE, Atlanta, GA 30329-2305. E-mail: [orders@ashrae.org](mailto:orders@ashrae.org). Fax: 678-539-2129. Telephone: 404-636-8400 (worldwide), or toll free 1-800-527-4723 (for orders in US and Canada). For reprint permission, go to [www.ashrae.org/permissions](http://www.ashrae.org/permissions).

© 2014 ASHRAE

ISSN 1041-2336



**ASHRAE Standing Standard Project Committee 140**  
**Cognizant TC: TC 4.7, Energy Calculations**  
**SPLS Liaison: Adam W. Hinge**

Ronald Judkoff, *Chair\**  
Joel Neymark, *Vice-Chair*  
Drury B. Crawley\*  
Phillip W. Falrey, III\*

Kamel Haddad\*  
Tianzhen Hong\*  
David E. Knebel\*  
Timothy P. McDowell\*

James F. Pegues\*  
Simon J. Rees\*  
Eric Sturm\*  
Michael J. Witte\*

\* Denotes members of voting status when the document was approved for publication

---

**ASHRAE STANDARDS COMMITTEE 2014–2015**

William F. Walter, *Chair*  
Richard L. Hall, *Vice-Chair*  
Karim Amrane  
Joseph R. Anderson  
James Dale Aswegan  
Charles S. Barnaby  
Steven F. Bruning  
John A. Clark  
Waller S. Clements

David R. Conover  
John F. Dunlap  
James W. Earley, Jr.  
Steven J. Emmerich  
Julie M. Ferguson  
Krishnan Gowri  
Cecily M. Grzywacz  
Rita M. Harrold  
Adam W. Hinge  
Debra H. Kennoy

Malcolm D. Knight  
Rick A. Larson  
Mark P. Modera  
Cyrus H. Nasser  
Janice C. Peterson  
Heather L. Platt  
Douglas T. Reindl  
Julia A. Keen, *BOD ExO*  
Thomas E. Werkema, Jr., *CO*

Stephanie C. Reiniche, *Manager of Standards*

---

**SPECIAL NOTE**

This American National Standard (ANS) is a national voluntary consensus standard developed under the auspices of ASHRAE. *Consensus* is defined by the American National Standards Institute (ANSI), of which ASHRAE is a member and which has approved this standard as an ANS, as "substantial agreement reached by directly and materially affected interest categories. This signifies the concurrence of more than a simple majority, but not necessarily unanimity. Consensus requires that all views and objections be considered, and that an effort be made toward their resolution." Compliance with this standard is voluntary until and unless a legal jurisdiction makes compliance mandatory through legislation.

ASHRAE obtains consensus through participation of its national and international members, associated societies, and public review.

ASHRAE Standards are prepared by a Project Committee appointed specifically for the purpose of writing the Standard. The Project Committee Chair and Vice-Chair must be members of ASHRAE; while other committee members may or may not be ASHRAE members, all must be technically qualified in the subject area of the Standard. Every effort is made to balance the concerned interests on all Project Committees.

The Manager of Standards of ASHRAE should be contacted for:

- a. interpretation of the contents of this Standard,
- b. participation in the next review of the Standard,
- c. offering constructive criticism for improving the Standard, or
- d. permission to reprint portions of the Standard.

**DISCLAIMER**

ASHRAE uses its best efforts to promulgate Standards and Guidelines for the benefit of the public in light of available information and accepted industry practices. However, ASHRAE does not guarantee, certify, or assure the safety or performance of any products, components, or systems tested, installed, or operated in accordance with ASHRAE's Standards or Guidelines or that any tests conducted under its Standards or Guidelines will be nonhazardous or free from risk.

**ASHRAE INDUSTRIAL ADVERTISING POLICY ON STANDARDS**

ASHRAE Standards and Guidelines are established to assist industry and the public by offering a uniform method of testing for rating purposes, by suggesting safe practices in designing and installing equipment, by providing proper definitions of this equipment, and by providing other information that may serve to guide the industry. The creation of ASHRAE Standards and Guidelines is determined by the need for them, and conformance to them is completely voluntary.

In referring to this Standard or Guideline and in marking of equipment and in advertising, no claim shall be made, either stated or implied, that the product has been approved by ASHRAE.

**(This foreword is not part of this standard. It is merely informative and does not contain requirements necessary for conformance to the standard. It has not been processed according to the ANSI requirements for a standard and may contain material that has not been subject to public review or a consensus process. Unresolved objections on informative material are not offered the right to appeal at ASHRAE or ANSI.)**

## FOREWORD

*The purpose of this addendum is to add a new set of test cases within new Section 5.2.4 of Standard 140. These test cases were adapted from IEA BESTEST In-Depth Diagnostic Cases for Ground Coupled Heat Transfer Related to Slab-On-Grade Construction, developed by the National Renewable Energy Laboratory in collaboration with the International Energy Agency.<sup>A-7</sup>*

### General Description of the New Test Cases

*Test procedures added in Section 5.2.4 use the results of verified detailed numerical models for ground-coupled heat transfer as a secondary mathematical truth standard for comparing the results of models typically used with whole-building energy simulation software; this is discussed further under “Analytical Verification Methodological Development.” The new test cases use an idealized uninsulated slab-in-grade configuration (slab interior surface level with exterior soil surface). This simplified configuration is required by the analytical solution of Case GC10a, is appropriate for developing robust ground-coupling test cases, is compatible with the tested programs, and facilitates development of accurate numerical model results by minimizing chances for input errors. These cases, as they step away from the analytical solution, also test parametric sensitivities to variation of floor slab aspect ratio, slab area, water table depth (depth of constant ground temperature), slab-interior and ground-exterior surface heat transfer coefficients, and slab and ground thermal conductivity. The cases use steady-state and harmonic boundary conditions as applied within artificially constructed annual weather data, along with an adiabatic above-grade building envelope to isolate the effects of ground-coupled heat transfer. Because the zone-heating load is driven exclusively by the slab heat losses, it is equal to the slab conduction heat loss. This is convenient for testing programs that may not readily disaggregate floor conduction losses in their output. Various output values—including steady-state, annual total steady-periodic, and annual peak hour steady-periodic results for floor conduction and zone heating load, along with time of occurrence of peak-hour loads and other supporting output—are compared and used in conjunction with a formal diagnostic method to determine algorithms responsible for predictive differences. The test cases are divided into three categories:*

- *The “a”-series cases (GC10a through GC40a) are for detailed numerical-methods programs (e.g., three-dimensional [3D] numerical models) that are either integrated within or run independently from whole-building energy simulation programs. Within the “a”-series*

*cases, Case GC10a provides a 3D steady-state analytical solution for rectangular surface geometry thermally coupled to a semi-infinite solid.<sup>A-4</sup> While Case GC10a incorporates boundary conditions that may be difficult to model in the context of a whole-building simulation, it provides an analytical solution reference result for checking detailed numerical models for overall correctness and proper application.*

- *The “b”-series cases (GC30b through GC80b) are for mid-level-detailed and simplified models likely to be used in whole-building simulation programs.*
- *The “c”-series cases (GC30c through GC80c) apply boundary conditions with a fixed interior combined surface coefficient assumption of  $7.95 \text{ W/m}^2\text{K}$  and the exterior ground surface temperature equal to the outdoor dry-bulb temperature (compatible with NRCAN’s BASESIMP program).*

*The test specification is structured such that the “b”-series cases, which are likely to be possible for more programs than the “a”- or “c”-series cases, are presented first. The “a”- and “c”-series cases, which are derived from the “b”-series cases (except for Case GC10a), are presented in later sections. If the program being tested can run the “a”-series cases as they are described, run the “a”-series cases before running any of the other cases.*

### Analytical Verification Methodological Development

*The new test cases use the results of detailed verified numerical models for ground-coupled heat transfer as a secondary mathematical truth standard, to which results from models typically used with whole-building energy simulation software can be compared. The logic for the cases may be summarized as follows:*

- *Identify or develop exact analytical solutions that may be used as mathematical truth standards for testing detailed numerical models using parameters and simplifying assumptions of the analytical solution.*
- *Apply a numerical solution process that demonstrates convergence in the space and time domains for the analytical-solution test cases and additional test cases where numerical models are applied.*
- *Once validated against the analytical solutions, use the numerical models to develop reference results for test cases that progress toward more realistic (less idealized) conditions and that do not have exact analytical solutions.*
- *Check the numerical models by carefully comparing their results to each other while developing the more realistic cases and make corrections as needed.*
- *Good agreement for the set of numerical models versus the analytical solution—and versus each other for subsequent test cases—verifies them as a secondary mathematical truth standard based on the range of disagreement among their results.*
- *Use the verified numerical-model results as reference results for testing other models that have been incorporated into whole-building simulation computer programs.*

This approach represents an important methodological advance to extend the analytical verification method beyond the constraints inherent in classical analytical solutions. It allows a secondary mathematical truth standard to be developed in the form of a set of stand-alone, detailed numerical models. Once verified against all available classical analytical solutions, and compared with each other for cases that do not have exact analytical solutions, the set of verified numerical models can be used together to test other models as implemented in whole-building simulation programs. This allows for greater diagnostic capability than the purely comparative method, and it allows somewhat more realistic boundary conditions to be used in the test cases than are possible with pure analytical solutions.

### Summary of Changes in this Addendum

- Add new Section 5.2.4, “Ground Coupled Slab-On-Grade Analytical Verification Tests” (This is the major substantive portion of the addendum).
- Update Section 6, “Class I Output Requirements,” to include output requirements related to Section 5.2.4.
- Update Section 3, “Definitions, Abbreviations, and Acronyms” for language of Section 5.2.4.
- Update Section 4, “Methods of Testing” (overall Standard 140 roadmap) to summarize new Section 5.2.4 test cases.
- Update normative Annex A1, “Weather Data,” to include weather data used for Section 5.2.4.
- Update normative Annex A2, “Standard Output Reports,” to include Section 5.2.4 results template.
- Update the following informative annexes to include new information relevant for Section 5.2.4 test procedures:
  - B1 “Tabular Summary of Test Cases”
  - B2 “About TMY Weather Data,” to provide editorial cross-referencing changes
  - B8 “Example Results for Building Thermal Envelope and Fabric Load and Ground-Coupled Slab-on-Grade Tests of Section 5.2”
  - B9 “Diagnosing The Results Using The Flow Diagrams”
  - B10 “Instructions for Working with Results Spreadsheets Provided with the Standard”
  - B11 “Production of Example Results for Building Thermal Envelope and Fabric Load and Ground-Coupled Slab-on-Grade Tests of Section 5.2”
  - B24 “Informative References”
- Update accompanying electronic files as called out in this addendum (see *Readme 140-2011-a.doc* with the accompanying electronic media).

#### Notes:

1. This addendum adapts BESTEST Ground-Coupled Slab-On-Grade Heat Transfer Cases for inclusion with Standard 140.
2. In this addendum, changes to the current standard are indicated in the text by underlining (for additions) and ~~striking through~~ (for deletions) unless the instructions specifically mention some other means of indicating

## Addendum a to Standard 140-2011

*Add the following definitions to Section 3.1. (Cross-referenced definitions are included for context only.)*

### 3.1 Terms Defined for This Standard

**adiabatic:** without loss or gain of heat (e.g., an adiabatic boundary does not allow heat to flow through it).

**analytical solution:** a mathematical solution of a model of reality that has a ~~deterministic~~ an exact result for a given set of parameters and simplifying assumptions. ~~boundary conditions.~~

**analytical verification:** where outputs from a program, subroutine, algorithm, or software object are compared to results from a known analytical solution or to results from a set of closely agreeing quasi-analytical solutions or verified numerical models.

**annual hourly integrated peak floor conduction:** the hourly floor conduction that represents the maximum for the final year of the simulation period, used for tests of Section 5.2.4.

**annual hourly integrated peak zone load:** the hourly zone load that represents the maximum for the final year of the simulation period, used for tests of Section 5.2.4.

**aspect ratio:** the ratio of the floor slab length to the floor slab width.

**combined radiative and convective surface coefficient:** a constant of proportionality relating the rate of combined convective and radiative heat transfer at a surface to the temperature difference across the air film on that surface.

**convective surface coefficient:** a constant of proportionality relating the rate of convective heat transfer at a surface to the temperature difference across the air film on that surface.

**convergence tolerance:** for an iterative solution process, the maximum acceptable magnitude of a selected error estimate; when the error criterion is satisfied, the process is deemed to have converged on a sufficiently accurate approximate solution.

**deep-ground temperature:** the ground temperature at or below a soil depth of 2 meters (6.56 ft), except for Section 5.2.4 ground coupling tests where the ground boundary depth varies as specified in the test cases.

**detailed ground heat transfer model:** employs transient 3D numerical-methods (finite-element or finite-difference) heat transfer modeling throughout the modeled domain.

**infrared emittance:** the ratio of the infrared spectrum radiant flux emitted by a body to that emitted by a blackbody at the same temperature and under the same conditions.

**mathematical truth standard:** the standard of accuracy for predicting system behavior based on an analytical solution.

**mid-level-detailed ground heat transfer model:** based on a transient 2D or 3D numerical-methods heat transfer model, applying some simplification(s) for adaptation to a whole-building energy simulation program; such models include correlation methods based on extensive 2D or 3D numerical analysis.

**quasi-analytical solution:** the mathematical solution of a model of reality for a given set of parameters and boundary conditions simplifying assumptions, which is allowed to include minor interpretation differences that cause minor results variations. **Informative Note:** Such a result-solution may be computed by generally accepted numerical methods or other means calculations, provided that such calculations occur outside the environment of a whole-building energy simulation program and can be scrutinized.

**secondary mathematical truth standard:** the standard of accuracy for predicting system behavior based on the range of disagreement of a set of closely agreeing verified numerical models or other quasi-analytical solutions, to which other simulations are allowed to be compared.

**simplified ground heat transfer model:** a model based on a 1D dynamic or steady-state heat transfer model; implementation of such a model usually requires no modification to a whole-building energy simulation program.

**verified numerical model:** a numerical model with solution accuracy verified by close agreement with an analytical solution and/or other quasi-analytical solution or numerical solutions, according to a process that demonstrates solution convergence in the space and time domains. **Informative Note:** Such numerical models may be verified by applying an initial comparison with an analytical solution(s), followed by comparisons with other numerical models for incrementally more realistic cases where analytical solutions are not available.

**Add the following abbreviations to Section 3.2 relevant to new language of Addendum A.**

### 3.2 Abbreviations and Acronyms Used in This Standard

AR	aspect ratio
$B$	floor slab length in north/south direction, m (ft)
$E$	deep-ground depth (Section 5.2.4 only), m
$F$	far field dimension, m (ft)
$h$	convective surface coefficient, $W/(m^2 \cdot K)$ ( $Btu/[h \cdot ft^2 \cdot ^\circ F]$ )
$h_{int}$	interior convective surface coefficient, $W/(m^2 \cdot K)$ ( $Btu/[h \cdot ft^2 \cdot ^\circ F]$ )
$h_{ext}$	exterior convective surface coefficient, $W/(m^2 \cdot K)$ ( $Btu/[h \cdot ft^2 \cdot ^\circ F]$ )
$k_{soil}$	soil/slab thermal conductivity, $W/(m \cdot K)$ ( $Btu/[h \cdot ft \cdot ^\circ F]$ )
$L$	floor slab length in east/west direction, m (ft)
$q$	heat flow, W or Wh/h
$q_{floor}$	floor conduction, W or Wh/h
$q_{floor,max}$	annual hourly integrated peak floor conduction, W or Wh/h
$q_{zone}$	zone load, W or Wh/h
$q_{zone,max}$	annual hourly integrated peak zone load, Wh/h or W
$Q_{floor}$	annual total floor conduction, kWh/y

$Q_{zone}$	annual total zone load, kWh/y
$T_{dg}, T_{dg}$	deep-ground temperature, $^\circ C$ ( $^\circ F$ )
Temp.	temperature, $^\circ C$ ( $^\circ F$ )
$T_i$	interior slab surface temperature, $^\circ C$ ( $^\circ F$ )
$T_{i,a}$	zone air temperature, $^\circ C$ ( $^\circ F$ )
$T_o$	exterior ground surface temperature, $^\circ C$ ( $^\circ F$ )
$T_{o,a}$	ambient air temperature, $^\circ C$ ( $^\circ F$ )
$T_{ODB,min}$	minimum hourly ambient temperature, $^\circ C$
$t_{sim}$	number of hours simulated (hours)
$T_{surf,n}$	near-surface temperature, $^\circ C$
$T_{@surf,n}$	at-surface temperature, Case GC10a only, $^\circ C$
$T_{zone}$	zone air temperature, $^\circ C$
$T_{zone,mean}$	annual average zone air temperature, $^\circ C$
v.	versus
$W$	slab/soil perimeter boundary width or wall thickness, m (ft) (Section 5.2.4 only)
$x$	variable dimension along x-axis, cm
$y$	variable dimension along y-axis, cm
1D	one-dimensional
2D	two-dimensional
3D	three-dimensional

**Revise Section 4 as shown; only the Section 4 material with changes is shown here. Changes include reference to the new test cases of Section 5.2.4 and other related annexes, and related editorial revisions.**

## 4. METHODS OF TESTING

**Informative Note:** Sections 4.2, 4.3, and 4.4 and all their subsections are informative material.]

[ . . . ]

### 4.2 Applicability of Test Method

The method of test is provided for analyzing and diagnosing building energy simulation software using software-to-software, software-to-analytical-solution, and software-to-quasi-analytical-solution, and software-to-verified numerical model comparisons. The methodology allows different building energy simulation programs, representing different degrees of modeling complexity, to be tested by:

- comparing the predictions from other building energy simulation programs to the Class-I test example simulation and verified numerical model results provided in informative Annex B8, to the Class-I test example analytical and quasi-analytical solutions and simulation results in the informative Annex B16, to the Class-II test example simulation results provided in Informative Annex B20, and/or to other results (simulations, or analytical and quasi-analytical solutions, or verified numerical model results) that were generated using this standard method of test;

**Add ground-coupled slab-on-grade analytical verification tests to Class I test procedures listing (4.3.a.1) as shown.**

#### 4.3 Organization of Test Cases. [ . . . ]

##### a. Class I test procedures

1. Building Thermal Envelope and Fabric Load Tests (see Section 4.3.1.1)
  - Building Thermal Envelope and Fabric Load Base Case (see Section 4.3.1.1.1)
  - Building Thermal Envelope and Fabric Load Basic Tests (see Section 4.3.1.1.2)
    - Low mass (see Section 4.3.1.1.2.1)
    - High mass (see Section 4.3.1.1.2.2)
    - Free float (see Section 4.3.1.1.2.3)
  - Building Thermal Envelope and Fabric Load In-Depth Tests (see Section 4.3.1.1.3)
  - Ground-Coupled Slab-On-Grade Analytical Verification Tests (see Section 4.3.1.1.4)

**Add new Section 4.3.1.1.4.**

**4.3.1.1.4 Ground-Coupled Slab-on-Grade Analytical Verification Tests.** These test cases use the results of detailed verified numerical models for ground-coupled heat transfer as a secondary mathematical truth standard for comparing the results of models typically used with whole-building energy simulation software. The test cases use an uninsulated slab-in-grade configuration (slab interior surface level with exterior soil surface). Parametric variations versus a steady-state base case (Case GC30b) include harmonically varying ground surface temperature, floor slab aspect ratio, slab area, water table depth (depth of constant ground temperature), slab-interior and ground-exterior surface heat transfer coefficients, and slab and ground thermal conductivity. The cases use steady-state and harmonic boundary conditions as applied within artificially constructed annual weather data, along with an adiabatic above-grade building envelope to isolate the effects of ground-coupled heat transfer. The test cases are structured within three categories: “b”-series cases (see Section 4.3.1.1.4.1), “a”-series cases (see Section 4.3.1.1.4.2), and “c”-series cases (see Section 4.3.1.1.4.3).

**4.3.1.1.4.1** The “b”-series cases (GC30b through GC80b) are for mid-level-detailed and simplified models likely to be used in whole-building simulation programs. These cases are presented in Section 5.2.4.1.

**4.3.1.1.4.2** The “a”-series cases (GC10a through GC40a) are for detailed numerical-methods programs (e.g., three-dimensional [3D] numerical models) that are either integrated within or run independently from whole-building energy simulation programs. Within the “a”-series cases, Case GC10a provides a 3D steady-state analytical solution for rectangular surface geometry. <sup>A-4</sup> These cases are presented in Section 5.2.4.2.

**4.3.1.1.4.3** The “c”-series cases (GC30c through GC80c) apply boundary conditions with a fixed interior combined surface coefficient assumption of  $7.95 \text{ W/m}^2\text{K}$  and the exterior ground surface temperature equal to the outdoor dry-

bulb temperature. These cases are presented in Section 5.2.4.3.

**Revise Section 4.4 as shown.**

**4.4 Comparing Output to Other Results.** For Class I test procedures:

- a. Annex B8, Section B8.1 gives example simulation results for the building thermal envelope and fabric load tests of Sections 5.2.1, 5.2.2, and 5.2.3
- b. Annex B8, Section B8.2 gives analytical solution, verified numerical model, and example simulation results for the ground-coupled slab-on-grade tests of Section 5.2.4
- c. ~~and~~ Annex B16 gives quasi-analytical solution results and example simulation results for the HVAC equipment performance tests of Sections 5.3 and 5.4.

For Class II test procedures (see Section 7), Annex B20 gives example simulation results. The user may choose to compare output with the example results provided in Annex B8, Annex B16, and Annex B20, or with other results that were generated using this standard method of test (including self-generated quasi-analytical solutions related to cases where such solutions are provided). ~~the HVAC equipment performance tests~~. For Class I test procedures, information about how the example results were produced is included in Informative Annex B11 for building thermal envelope and fabric load and ground-coupled slab-on-grade tests, and in Informative Annex B17 for HVAC equipment performance tests. For Class II test procedures, information about how the example results were produced is included in Informative Annex B21. For the convenience to users who wish to plot or tabulate their results along with the example results, electronic versions of the example results are included with the accompanying electronic media: for Annex B8 with the files RESULTS5-2A.XLS and RESULTS5-2B.XLSX; for Annex B16 with the files RESULTS5-3A.XLS, RESULTS5-3B.XLS, and RESULTS5-4.XLS; and for Annex B20 with the file RESULTS7-2.XLS. Documentation for navigating these results files is included on the accompanying electronic media and is printed in Annex B10.

**4.4.1 Criteria for Determining Agreement between Results.** The requirements of the normative sections of Standard 140 ensure that users follow the specified method of test and that test results are provided as specified. There are no formal criteria for when results agree or disagree with either the example results provided in informative Annexes B8, B16, or B20, or with other results generated using this method of test. Determination of when results agree or disagree is left to the organization referencing the method of test, or to other users that may be running the tests for their own quality assurance purposes. In making this determination, the following should be considered:

- a. Magnitude of results for individual cases
- b. Magnitude of difference in results between certain cases (e.g., “Case 610 – Case 600”)

- c. Same direction of sensitivity (positive or negative) for difference in results between certain cases (e.g., “Case 610 – Case 600”)
- d. Whether results are logically counterintuitive with respect to known or expected physical behavior
- e. Availability of analytical or quasi-analytical solution results (i.e., mathematical truth standard as described in informative Annex B16, Section B16.2), or verified numerical-model results (i.e., secondary mathematical truth standard as described in informative Annex B8, Section B8.2.1)
- f. For the ~~space-cooling and space-heating equipment performance analytical verification tests of Section 5.3 and 5.4~~, the degree of disagreement that occurred for other simulation results in ~~Annex B16~~ versus the analytical solution, and quasi-analytical solution, or verified numerical model results
- g. Example simulation results do not represent a truth standard.

**Revise Sections 5.1.2 and 5.1.8 as noted.**

**5.1.2 Geometry Convention.** If the program being tested includes the thickness of walls in a three-dimensional definition of the building geometry, then wall, roof, and floor thicknesses shall be defined such that the interior air volume of the building model remains as specified (e.g., for the building thermal envelope and fabric load test cases of Sections 5.2.1, 5.2.2, and 5.2.3,  $6 \times 8 \times 2.7 \text{ m} = 129.6 \text{ m}^3$  [ $19.7 \times 26.2 \times 8.9 \text{ ft} = 4576.8 \text{ ft}^3$ ]).

[ . . . ]

### 5.1.8 Simulation Duration

**5.1.8.1** Results for the tests of Sections 5.2.1, 5.2.2, 5.2.3, 5.3.3, and 5.3.4 shall be taken from full annual simulations.

**5.1.8.2** For the tests of Section 5.2.4, if the program being tested allows multiyear simulations, models shall run for a number of years to satisfy the requirements of specific test cases. If the software being tested is not capable of sufficient simulation duration to satisfy the requirements of specific test cases, the simulation shall be run for the maximum duration allowed by the software being tested. **Informative Note:** The duration to achieve requirements of specific test cases may vary among the test cases.

**5.1.8.3** For the tests of Sections 5.3.1 and 5.3.2, the simulation shall be run for at least the first two months for which the weather data are provided. Provide output for the second month of the simulation (February) in accordance with Section 6.3.1. **Informative Note:** The first month of the simulation period (January) serves as an initialization period.

**5.1.8.4** For the tests of Section 5.4, the simulation shall be run for at least the three first months for which the weather data are provided. Provide output for the first three months of the year (January 1–March 31) in accordance with Section 6.4.

**Revise Section 5.2.1 as indicated.**

## 5.2 Input Specifications for Building Thermal Envelope and Fabric Load Tests

**5.2.1 Case 600: Base Case.** Begin with Case 600. Case 600 shall be modeled as specified in this section and its subsections. **Informative Note:** The bulk of the work for implementing the ~~Section 5.2~~ tests is assembling an accurate base building model. It is recommended that base building inputs be double checked and results disagreements be diagnosed before going on to the other cases.

### 5.2.1.1 Weather and Site Data

**5.2.1.1.1 Weather Data.** The DRYCOLD.TMY weather data provided with the electronic files accompanying this standard shall be used for all cases in Sections 5.2.1, 5.2.2, and 5.2.3. These data are described in Normative Annex A1, Section A1.1.1.

**5.2.1.1.2 Site Data.** The site parameters provided in Normative Annex A1, Table A1-1a shall be used.

**Update Section 5.2.1.2 as shown.**

**5.2.1.2 Output Requirements.** Case 600 requires the following output:

[ . . . ]

**Informative Note:** In this description, the term “free-float cases” refers to cases designated with FF in the case description (i.e., 600FF, 650FF, 900FF, 950FF); non-free-float cases are all the other cases described in Sections 5.2.1, 5.2.2, and 5.2.3. (Tables B1-1a and B1-1b of Annex B1 include an informative summary listing of the cases of Sections 5.2.1, 5.2.2, and 5.2.3).

**Add new Section 5.2.4. Renumber subsequent tables and figures to account for the addition of Section 5.2.4.**

### 5.2.4 Ground-Coupled Slab-On-Grade Analytical Verification Tests

**5.2.4.1 “b”-Series Cases.** The “b”-series cases shall be modeled as specified in this section. Case GC30b shall be the first case modeled and all other tests in this series shall be sequential revisions to a previously completed model. The base case models for each case shall be:

Case	Basis for Case
GC40b	GC30b
GC45b	GC40b
GC50b	GC40b
GC55b	GC40b
GC60b	GC30b
GC65b	GC60b
GC70b	GC40b
GC80b	GC40b

**Informative Note:** The “b”-series cases are for mid-level-detailed and simplified models likely to be used in whole-building energy simulation programs. The bulk of the work

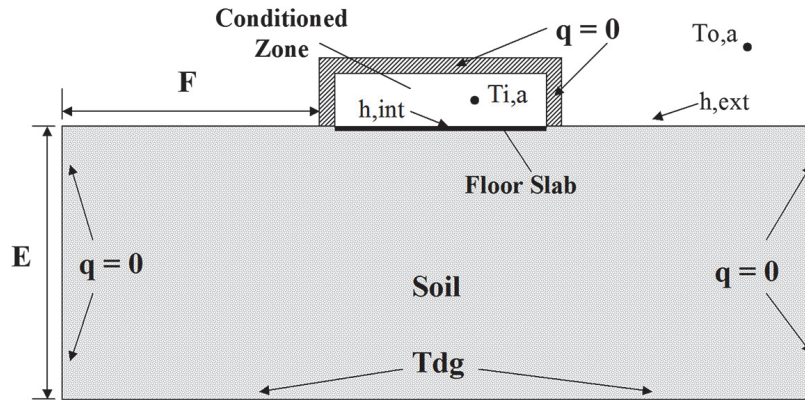

**FIGURE 5-8 Case GC30b conceptual schematic diagram, including boundary conditions and soil dimensions.**

for implementing the test cases is assembling an accurate base case. It is recommended to double check the Case GC30b base case inputs and to diagnose Case GC30b results disagreements before going on to the other test cases.

**5.2.4.1.1 Case GC30b—“b”-Series Steady-State Base Case.** Case GC30b shall be modeled as specified in this section and its subsections.

***Informative Notes:***

1. **Objective of the Test Case:** Compare steady-state heat flow results from whole-building simulation programs to the verified numerical-model results (secondary mathematical truth standard).
2. **Method of the Test Case:** This case drives floor conduction based on the temperature difference between zone air and ambient air (and deep-ground boundary condition) using an adiabatic zone except for the floor (so that zone load should equal floor conduction), with an adiabatic wall/ground interface boundary (see Figure 5-8) and interior and exterior air temperatures with high convective surface coefficients. High convective surface coefficients facilitate robust floor conduction and establish somewhat uniform temperatures for the interior slab surface and exterior ground surfaces. Soil and far-field boundary conditions are also described. These boundary conditions are allowed by more whole-building simulation programs than those of Case GC10a or Case GC30a. Comparison of GC30b versus GC30a (GC30b–GC30a) checks the sensitivity to high convective surface coefficients versus direct-input constant and uniform surface temperature boundary conditions.

**5.2.4.1.1.1 Geometry and General Description.**

Geometry and location of boundary conditions shall be modeled as described in Figures 5-8 and 5-9. Interior edges of zone walls shall begin at the edges of the surface defined by the area  $B \times L$  in Figure 5-9. The slab edge detail shall be modeled as described in Figure 5-10. Parameters related to these figures and other input parameters described in Table 5-23 and the following sections shall be used.

**5.2.4.1.1.2 Soil and Slab Thermal Properties and Boundary Conditions**

- a. The soil and floor slab properties shall be constant and equal to:

Thermal conductivity = 1.9 W/(m·K) (1.098 Btu/(h·ft·°F))

Density = 1490 kg/m<sup>3</sup> (93.125 lb/ft<sup>3</sup>)

Specific heat = 1800 J/(kg·K) (0.4302 Btu/(lb·°F)).

- b. Initially (time < 0) the ground and slab shall be 10°C (50°F) throughout. *Informative Note:* At the beginning of the simulation (time = 0), the zone air temperature steps to 30°C (86°F) per Section 5.2.4.1.1.5, and slab and soil temperatures begin to change accordingly.
- c. No surface radiation exchange. *Informative Note:* One possible method to disable radiation exchange is to set exterior solar absorptances and infrared emittances to 0, or as low as the program being tested allows (e.g., 0.000001).
- d. The ground is not shaded except by the building. *Informative Note:* Shading and orientation are not relevant with radiative exchange disabled.
- e. The ground surface shall be uniform and flat.
- f. Interior floor slab and outside ground surfaces are level with each other.
- g. Models requiring input of slab thickness shall use the least thickness that the software allows, and that results in a stable calculation.
- h. Models requiring input for below-grade foundation walls shall use the soil thermal properties specified above for the foundation wall, with foundation wall dimensions as small as the model being tested allows and that results in a stable calculation.
- i. Deep-ground temperature shall be constant and uniform at the given depth.
- j. Far-field ground conditions shall be adiabatic for vertical planes penetrating the ground at the given far-field distance from the surface.
- k. Ambient air temperature shall be uniform (well-mixed air).



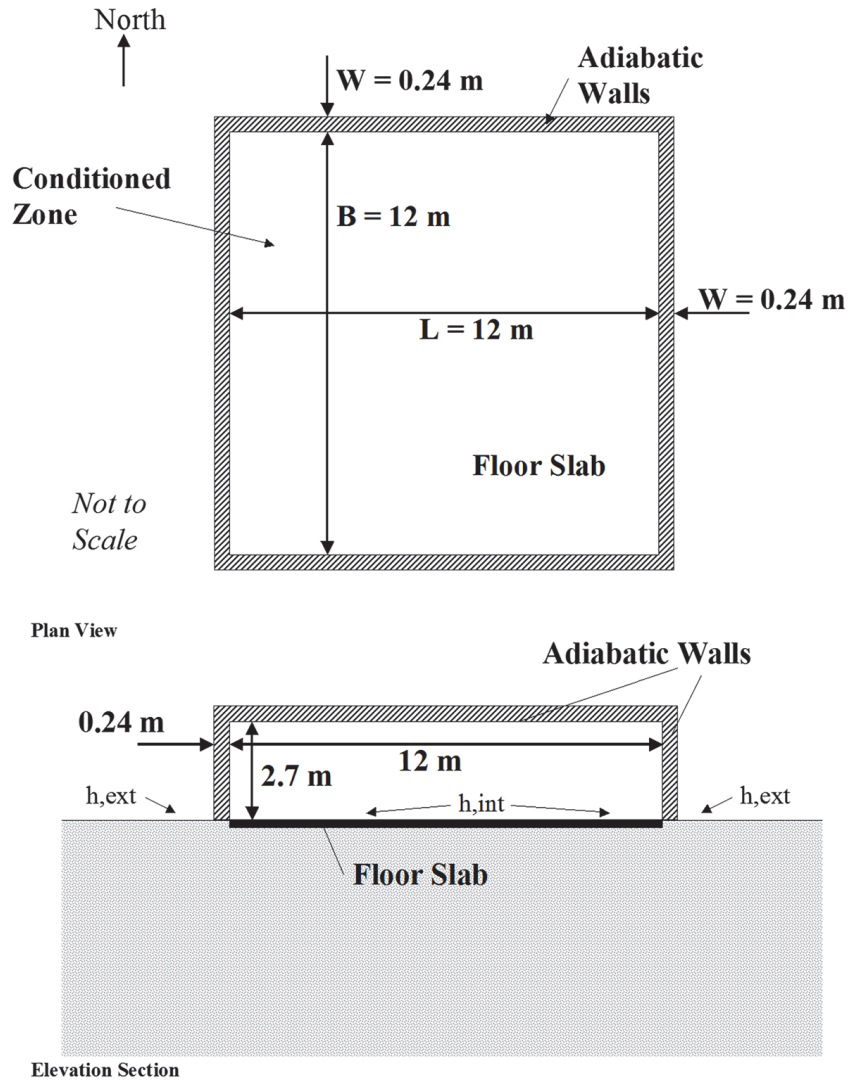

**FIGURE 5-9 Case GC30b floor slab and conditioned zone adiabatic wall dimensions.**

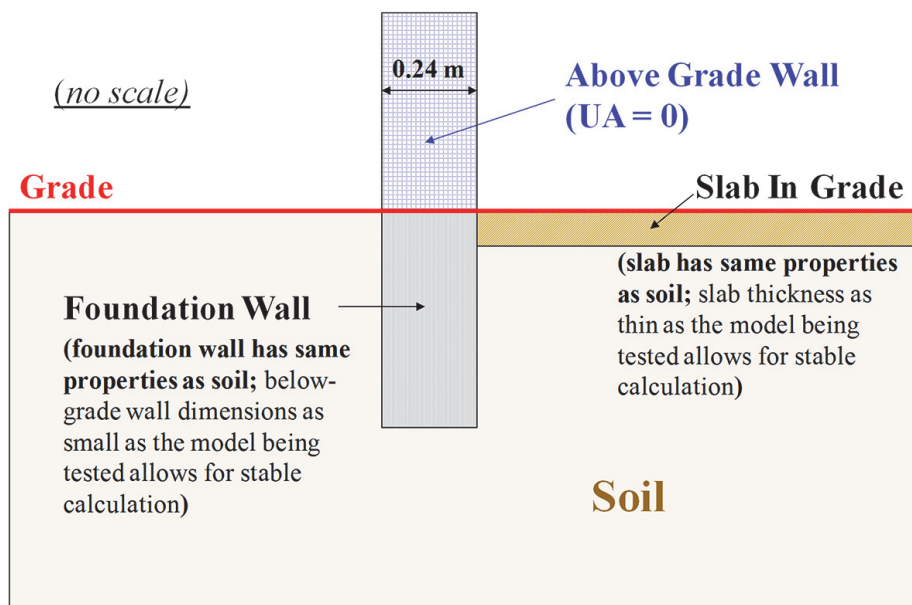

**FIGURE 5-10 Case GC30b slab edge detail.**

**TABLE 5-23 Case GC 30b Input Parameters**

Test Parameters	SI	I-P
Slab length (L)	12 m	39.37 ft
Slab width (B)	12 m	39.37 ft
Wall thickness (W)	0.24 m	0.7874 ft
Inside zone air temperature ( $T_{i,a}$ )	30°C	86°F
Outside air temperature ( $T_{o,a}$ )	10°C	50°F
Deep-ground temperature ( $T_{dg}$ )	10°C	50°F
Deep-ground boundary depth (E)	15 m	49.21 ft
Far field boundary distance (F)	15 m	49.21 ft

- l. Evapotranspiration shall not be modeled. If the program being tested is capable of modeling evapotranspiration, it shall be turned off or reduced to the lowest level allowed by the program.

**5.2.4.1.1.3 Above-Grade Construction**

- a. Building height = 2.7 m (8.858 ft).
- b. Zone air volume = 388.8 m<sup>3</sup> (13730 ft<sup>3</sup>).
- c. All surfaces of the zone except the floor are adiabatic (thermal conductance = 0 W/(m<sup>2</sup>·K) [0 Btu/(h·ft<sup>2</sup>·°F)]). If the program being tested does not allow adiabatic surfaces, the lowest thermal conductance the program allows shall be used. **Informative Note:** e.g., thermal conductance = 0.000001 W/(m<sup>2</sup>·K) is a sufficiently small value.
- d. All surfaces except the floor are massless. If the program being tested does not allow massless surfaces, the lowest density or thermal capacitance, or both, that the program allows shall be used. **Informative Note:** e.g., density = 0.000001 kg/m<sup>3</sup> (0.0000001 lb/ft<sup>3</sup>) or thermal capacitance = 0.000001 J/(kg·K) (0.000001 Btu/[lb·°F]), or both, are sufficiently small values.
- e. The adiabatic walls shall contact, but not penetrate, the ground. Heat shall not flow between the ground and the adiabatic walls. **Informative Note:** Heat may flow within the ground just below the adiabatic walls.
- f. Surface radiation exchange shall not be modeled. **Informative Note:** One possible method to disable radiation exchange is to set interior and exterior solar absorptances and infrared emittances to 0, or as low as the program being tested allows (e.g., 0.000001).
- g. No windows.
- h. No infiltration or ventilation.
- i. No internal gains.

**5.2.4.1.1.4 Convective Surface Coefficients**

- a. Interior convective surface coefficients ( $h_{int}$ ) = 100 W/(m<sup>2</sup>·K) (17.61 Btu/[h·ft<sup>2</sup>·°F]).
- b. Exterior convective surface coefficients ( $h_{ext}$ ) = 100 W/(m<sup>2</sup>·K) (17.61 Btu/[h·ft<sup>2</sup>·°F]).

These values shall apply to surface coefficients for the floor, adiabatic surfaces, and exterior ground surface. If the

program being tested cannot model these convective surface coefficients, the largest value the program allows shall be used.

If the program being tested allows direct user input of convective surface coefficients and surface infrared (IR) emittances, then skip the remainder of this paragraph and proceed to Section 5.2.4.1.1.5. If the program being tested allows only direct user input of combined surface coefficients, set that value to 100 W/(m<sup>2</sup>·K) (17.61 Btu/[h·ft<sup>2</sup>·°F]). If the program being tested does not allow direct user input of convective surface coefficients or combined surface coefficients, input a value for IR emittance such that an equivalent value for combined surface coefficient of 100 W/(m<sup>2</sup>·K) (17.61 Btu/[h·ft<sup>2</sup>·°F]) is obtained as closely as the program being tested is capable of, based on the convective surface coefficient that the program being tested automatically calculates.

**5.2.4.1.1.5 Mechanical System.** The mechanical system shall provide sensible heating only (no cooling). The system shall be modeled as follows, as closely as the program being tested allows:

- a. Heating setpoint = ON if temperature < 30°C (86°F); otherwise heat = OFF.
- b. Cooling setpoint = always OFF.
- c. The heating system capacity shall be large enough to maintain the zone air temperature setpoint. **Informative Note:** For example, 1000 kW (3412 kBtu/h). **Informative Note:** This specification for the heating capacity is repeated for steady-state cases where floor conduction of the verified numerical models is greater for the given case than for its designated base case.
- d. Uniform zone air temperature (well-mixed air).
- e. 100% efficiency.
- f. 100% convective air system.
- g. Ideal controls with the zone air temperature always at the thermostat setpoint. **Informative Note:** For example, assume the heat addition rate equals the equipment capacity (nonproportional control) and there is continuous ON/OFF cycling within the hour as needed.
- h. The thermostat shall sense the zone air temperature only.

**Informative Note:** The purpose of this idealized heating system is to give results for energy consumption that are equal to the sensible heating load.

**5.2.4.1.1.6 Weather Data.** The constant temperature TMY2 format weather data provided with the following file, included on the accompanying electronic media, shall be used: GC30b.TM2.

If the program does not utilize site data from the weather data file, the site parameters provided in normative Annex A1, Section A1.1.2 shall be used.

**Informative Note:** Supporting details for this weather data are provided in Annex A1, Section A1.1.2. Other cases call for different weather files as needed.

**5.2.4.1.1.7 Modeling Precision**

**5.2.4.1.1.7.1 Simulation Duration.** The simulation shall be run until there is ≤0.1% variation between the floor slab conduction for the last hour of the last year of the simulation and the last hour of the preceding year of the simulation. If the software being tested is not capable of this, the

simulation duration shall be for as long as the software being tested is capable of running.

**Informative Notes:**

1. **Thermal Node Mesh:** If the numerical model being tested allows variation of thermal node meshing, it is recommended to demonstrate for a subset of the steady-state and steady-periodic cases (e.g., GC30b, GC40b, and others if desired) that the tested mesh detail yields negligible ( $\leq 0.1\%$ ) change in results versus a less detailed mesh, or that the mesh is as detailed as possible for the available computing hardware.
2. **Convergence Tolerance:** If the software being tested allows user specification of convergence tolerance, it is recommended to demonstrate for a subset of the steady-state and steady-periodic cases (e.g., GC30b and GC40b) that the current level of heat-flow or temperature convergence tolerance yields negligible ( $\leq 0.1\%$ ) change in results versus the next finer convergence tolerance.

**5.2.4.1.1.8 Output Requirements.** Output shall be provided in accordance with Section 6.2.2.1.

**5.2.4.1.2 Case GC40b—Harmonic Variation of Ambient Temperature.** Case GC40b shall be modeled as specified in this section.

**Informative Notes:**

1. **Objective of the Test Case:** Compare heat flow results for approximate steady-periodic (harmonic) variation of ambient temperature ( $T_{o,a}$ ) from whole-building simulation programs versus verified numerical-model results. Analyze the phase shift between variations of heat flow and ambient air temperature.
2. **Method of the Test Case:** This case is similar to Case GC30b but uses harmonically varying  $T_{o,a}$ . Hourly TMY2 format weather data are provided for approximating a sinusoidal annual cycle of varying daily average temperatures with a sinusoidal diurnal temperature cycle overlaid (a high frequency cycle overlaid on a low frequency cycle). Comparing GC40b with GC30b (GC40b—GC30b) annual hourly average floor conduction checks the sensitivity of average floor heat loss of the harmonic condition versus the steady-state condition.

**5.2.4.1.2.1 Input Specification.** This case shall be modeled exactly as Case GC30b except for the following changes:

- a. **Weather Data.** The weather data provided with the following file, included on the accompanying electronic media, shall be used: GC40b.TM2.

If the program does not utilize site data from the weather data file, the site parameters provided in normative Annex A1, Section A1.1.2 shall be used.

**Informative Note:** These data are described in Annex A1, Section A1.1.2; see Section A1.1.2.1 regarding harmonically varying inputs.

- b. **Heating System Capacity.** The heating system capacity shall be set so there is at least enough capacity to maintain the zone air temperature setpoint during the peak heating-load hour. **Informative Note:** The heating capacity may vary among the test cases. This specification for the heating capacity is repeated for harmonically varying cases where floor conduction of the verified numerical models is greater for the given case than for its designated base case.
- c. **Simulation Duration.** The simulation shall be run until there is  $\leq 0.1\%$  variation between the annual floor slab conduction for the last year of the simulation and the preceding year of the simulation. If the software being tested is not capable of this, the simulation duration shall be for as long as the software being tested is capable of running.

**5.2.4.1.2.2 Output Requirements.** Output shall be provided in accordance with Section 6.2.2.2.

**5.2.4.1.3 Case GC45b—Aspect Ratio.** Case GC45b shall be modeled as specified in this section.

**Informative Notes:**

1. **Objective of the Test Case:** Test the sensitivity to variation of aspect ratio (AR) in the context of steady-periodic (harmonic) variation of  $T_{o,a}$ . The AR for a given slab area directly affects the ratio of perimeter heat transfer to core heat transfer. In this context the use of the term *perimeter* is different from the perimeter boundary described in Case GC10a. Here, perimeter heat transfer is the heat transfer driven by the zone-to-ambient air temperature difference through a relatively thin layer of soil; core heat transfer is driven by the zone-to-deep-ground temperature difference, through a relatively thick layer of soil.
2. **Method of the Test Case:** This case is similar to Case GC40b. It uses a slab with same surface area but different AR. Comparison of results for GC45b versus GC40b (GC45b—GC40b) checks the sensitivity of AR. Compare heat-flow results from whole-building simulation programs to verified numerical-model results. Analyze phase shift between variations of heat flow and  $T_{o,a}$ .

**5.2.4.1.3.1 Input Specification.** This case shall be modeled exactly as Case GC40b except for the following changes:

- a. **Slab Dimensions.** The slab dimensions shall be modeled as specified in Table 5-24.
- b. **Heating System Capacity.** The heating system capacity shall be modeled as needed so there is at least enough capacity to maintain the zone air temperature setpoint during the peak heating-load hour.

**5.2.4.1.3.2 Output Requirements.** Output shall be provided in accordance with Section 6.2.2.2 except slab dimensions  $L$  and  $B$  from Table 5-24 shall be used.

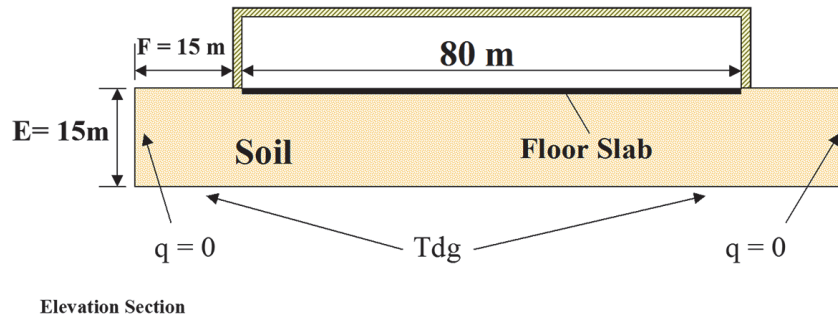

FIGURE 5-11 Case GC50b dimensions and below-grade boundary conditions.

TABLE 5-24 Case GC45b Slab Dimensions

Test Parameters	SI	I-P
Slab length (L)	36 m	118.11 ft
Slab width (B)	4 m	13.12 ft

TABLE 5-25 Case GC50b Input Parameters

Test Parameters	SI	I-P
Slab length (L)	80 m	262.47 ft
Slab width (B)	80 m	262.47 ft
Deep-ground boundary depth (E)	15 m	49.21 ft
Far field boundary distance (F)	15 m	49.21 ft

5.2.4.1.4 Case GC50b—Large Slab. Case GC50b shall be modeled as specified in this section.

**Informative Notes:**

1. **Objective of the Test Case:** Test the sensitivity to variation of slab size in the context of steady-periodic (harmonic) variation of  $T_{o,a}$ . Increasing the slab size yields a larger fraction of core-driven ground heat transfer that is driven by the difference between the zone air temperature and the deep-ground temperature.
2. **Method of the Test Case:** This case is similar to Case GC40b but uses a large slab. Comparing results for *heat flow per unit floor area* (flux) for GC50b versus GC40b (GC50b–GC40b) checks the sensitivity to heat transfer caused by increasing the slab size. Compare heat-flow results from whole-building simulation programs to verified numerical-model results. Analyze phase shift between variations of heat flow and  $T_{o,a}$ .

5.2.4.1.4.1 Input Specification. This case shall be modeled exactly as Case GC40b except for the following changes:

TABLE 5-26 Case GC55b Deep-Ground Boundary Depth

Test Parameters	SI	I-P
Deep-ground boundary depth (E)	2 m	6.562 ft

a. **Geometry.** Dimensions shall be modeled as specified in Figure 5-11 and Table 5-25.

b. **Heating System Capacity.** The heating system capacity shall be set so there is at least enough capacity to maintain the zone air temperature setpoint during the peak heating-load hour.

5.2.4.1.4.2 Output Requirements. Output shall be provided in accordance with Section 6.2.2.2.

5.2.4.1.5 Case GC55b—Shallow Deep-Ground Temperature. Case GC55b shall be modeled as specified in this section.

**Informative Notes:**

1. **Objective of the Test Case:** Test the sensitivity to variation of deep-ground temperature depth in the context of steady-periodic (harmonic) variation of  $T_{o,a}$ . This case is relevant for areas with a relatively shallow groundwater table, which increases the effect of core heat flow that is driven by the difference between the zone air temperature and the deep-ground temperature.
2. **Method of the Test Case:** This case is similar to Case GC40b but uses a shallower deep-ground boundary (heat sink) location. Comparison of results for GC55b versus GC40b (GC55b–GC40b) checks the sensitivity of deep-ground temperature depth. Compare heat-flow results from whole-building simulation programs to verified numerical-model results. Analyze phase shift between variations of heat flow and  $T_{o,a}$ .

5.2.4.1.5.1 Input Specification. This case shall be modeled exactly as Case GC40b except for the following changes:

- a. **Deep-Ground Boundary.** The deep-ground temperature boundary depth shall be modeled as specified in Table 5-26.
- b. **Heating System Capacity.** The heating system capacity shall be set so there is at least enough capacity to maintain the zone air temperature setpoint during the peak heating-load hour.

5.2.4.1.5.2 Output Requirements. Output shall be provided in accordance with Section 6.2.2.2.

**5.2.4.1.6 Case GC60b—Steady State with Typical Interior Convective Surface Coefficient.** Case GC60b shall be modeled as specified in this section.

**Informative Notes:**

- Objective of the Test Case:** Test sensitivity to the use of a more realistic interior convective surface heat transfer coefficient ( $h_{int}$ ) in the steady-state context. With a more realistic coefficient, the zone floor surface temperature will be less uniform and will exhibit greater decrease outward from the center toward the zone perimeter boundary.
- Method of the Test Case:** This case is similar to Case GC30b but uses decreased  $h_{int}$ . Comparison of results for GC60b versus GC30b (GC60b–GC30b) checks the sensitivity of  $h_{int}$ . Compare heat-flow results from whole-building simulation programs to verified numerical-model results.

**5.2.4.1.6.1 Input Specification.** This case shall be modeled exactly as Case GC30b except for the following changes:

- Interior Convective Surface Coefficient.** The value for  $h_{int}$  shall be modeled as specified in Table 5-27. This value of  $h_{int}$  shall be applied to the interior side of the floor and other zone surfaces (i.e., walls and ceiling).

Surface IR emittances shall be modeled as 0 (or as low as the program being tested allows). If the program being tested allows direct user input of interior convective surface coefficients and interior surface IR emittances, then skip the remainder of this paragraph and proceed to Section 5.2.4.1.6.2. If the program being tested allows direct user input of combined interior surface coefficients only, set that value to  $7.95 \text{ W}/(\text{m}^2\cdot\text{K})$  ( $1.3999 \text{ Btu}/[\text{h}\cdot\text{ft}^2\cdot^\circ\text{F}]$ ). If the program being tested does not allow direct user input of convective surface coefficients or combined surface coefficients, input a value for IR emittance such that an equivalent value for a combined surface coefficient of  $7.95 \text{ W}/(\text{m}^2\cdot\text{K})$  ( $1.3999 \text{ Btu}/[\text{h}\cdot\text{ft}^2\cdot^\circ\text{F}]$ ) is obtained as closely as the program being tested is capable of, based on the convective surface coefficient that the program being tested automatically calculates.

**5.2.4.1.6.2 Output Requirements.** Output shall be provided in accordance with Section 6.2.2.1.

**5.2.4.1.7 Case GC65b—Steady State with Typical Interior and Exterior Convective Surface Coefficients.** Case GC65b shall be modeled as specified in this section.

**Informative Notes:**

- Objective of the Test Case:** Test sensitivity to the use of a more realistic exterior convective surface coefficient ( $h_{ext}$ ) in the steady-state context. With a more realistic coefficient, the exterior ground surface temperature will be less uniform and will exhibit greater increase near the exterior side of the adiabatic wall.
- Method of the Test Case:** This case is similar to Case GC60b but uses decreased  $h_{ext}$ . Comparison of results for GC65b versus GC60b (GC65b–

**TABLE 5-27 Case GC60b Interior Convective Surface Coefficient**

Test Parameters	SI	I-P
$h_{int}$ (interior convective surface coefficient)	$7.95 \text{ W}/(\text{m}^2\cdot\text{K})$	$1.3999 \text{ Btu}/(\text{h}\cdot\text{ft}^2\cdot^\circ\text{F})$

**TABLE 5-28 Case GC65b Interior and Exterior Convective Surface Coefficients**

Test Parameters	SI	I-P
$h_{int}$ (interior convective surface coefficient)	$7.95 \text{ W}/(\text{m}^2\cdot\text{K})$	$1.3999 \text{ Btu}/(\text{h}\cdot\text{ft}^2\cdot^\circ\text{F})$
$h_{ext}$ (exterior [ground] convective surface coefficient)	$11.95 \text{ W}/(\text{m}^2\cdot\text{K})$	$2.1043 \text{ Btu}/(\text{h}\cdot\text{ft}^2\cdot^\circ\text{F})$

GC60b) checks the sensitivity of  $h_{ext}$ . Comparison of results for GC65b versus GC30b (GC65b–GC30b) checks the combined effect of sensitivity to  $h_{int}$  and  $h_{ext}$ . Compare heat-flow results from whole-building simulation programs to verified numerical-model results.

**5.2.4.1.7.1 Input Specification.** This case shall be modeled exactly as Case GC60b except for the following changes:

- Exterior Convective Surface Coefficient.** The value for  $h_{ext}$  shall be modeled as specified in Table 5-28. This value of  $h_{ext}$  shall be applied to the exterior ground surface and to other zone exterior surfaces (i.e., walls and ceiling). **Informative Note:** The value for  $h_{int}$  is repeated in Table 5-28 for convenience.

Surface IR emittances shall be modeled as 0 (or as low as the program being tested allows). If the program being tested allows direct user input of  $h_{ext}$  and exterior surface IR emittances, then skip the remainder of this paragraph and proceed to Section 5.2.4.1.7.1, item b (just below). If the program being tested allows direct user input of combined exterior surface coefficients only, set that value to  $11.95 \text{ W}/(\text{m}^2\cdot\text{K})$  ( $2.1043 \text{ Btu}/[\text{h}\cdot\text{ft}^2\cdot^\circ\text{F}]$ ). If the program being tested does not allow direct user input of convective surface coefficients or combined surface coefficients, input a value for IR emittance such that an equivalent value for combined surface coefficient of  $11.95 \text{ W}/(\text{m}^2\cdot\text{K})$  ( $2.1043 \text{ Btu}/[\text{h}\cdot\text{ft}^2\cdot^\circ\text{F}]$ ) is obtained as closely as the program being tested is capable of, based on the convective surface coefficient that the program being tested automatically calculates.

- Weather Data.** The weather data provided with the following file, included on the accompanying electronic media, shall be used: GC65b.TM2.

If the program does not utilize site data from the weather data file, the site parameters provided in normative Annex A1, Section A1.1.2 shall be used.

**5.2.4.1.7.2 Output Requirements.** Output shall be provided in accordance with Section 6.2.2.1.

**5.2.4.1.8 Case GC70b—Harmonic Variation of Ambient Temperature with Typical Interior and Exterior Convective Surface Coefficients.** Case GC70b shall be modeled as specified in this section.

**Informative Notes:**

1. **Objective of the Test Case:** Test sensitivity to the use of more realistic  $h_{int}$  and  $h_{ext}$  in the context of steady-periodic (harmonic) variation of  $T_{o,a}$ .
2. **Method of the Test Case:** This case is similar to Case GC40b but uses decreased  $h_{int}$  and  $h_{ext}$ . Comparison of results for GC70b versus GC40b (GC70b–GC40b) checks the combined sensitivities of  $h_{int}$  and  $h_{ext}$ . Compare heat-flow results from whole-building simulation programs to verified numerical-model results. Analyze phase shift between variations of heat flow and  $T_{o,a}$ . Comparison of GC70b versus GC65b (GC70b–GC65b) annual hourly average floor conduction checks the sensitivity of average floor heat loss of the harmonic versus the steady-state condition in the context of using realistic convective surface coefficients.

**5.2.4.1.8.1 Input Specification.** This case shall be modeled exactly as Case GC40b except for the following changes:

- a. **Convective Surface Coefficients.**  $h_{int}$  and  $h_{ext}$  shall be modeled as specified in Table 5-28 (see Section 5.2.4.1.7.1).
- b. **Weather Data.** The weather provided with the following file, included on the accompanying electronic media, shall be used: GC70b.TM2.

If the program does not utilize site data from the weather data file, the site parameters provided in normative Annex A1, Section A1.1.2 shall be used.

**Informative Note:** See Annex A1, Section A1.1.2.1 regarding harmonically varying inputs.

**5.2.4.1.8.2 Output Requirements.** Output shall be provided in accordance with Section 6.2.2.2.

**5.2.4.1.9 Case GC80b—Reduced Slab and Ground Conductivity.** Case GC80b shall be modeled as specified in this section.

**Informative Notes:**

1. **Objective of the Test Case:** Test sensitivity to reduced slab and ground conductivity in the context of steady-periodic (harmonic) variation of  $T_{o,a}$ .
2. **Method of the Test Case:** This case is similar to Case GC40b but uses decreased slab and ground conductivity. Comparison of results for GC80b versus GC40b (GC80b–GC40b) checks the sensitivity of slab and ground conductivity. Compare heat-flow results from whole-building simulation programs to verified numerical-model results. Analyze phase shift between variations of heat flow and  $T_{o,a}$ .

**5.2.4.1.9.1 Input Specification.** This case shall be modeled exactly as Case GC40b except for the following change:

Soil and slab thermal conductivity = 0.5 W/(m·K) (0.289 Btu/[h·ft·°F])

**5.2.4.1.9.2 Output Requirements.** Output shall be provided in accordance with Section 6.2.2.2.

**5.2.4.2 “a”-Series Cases.** The “a”-series cases shall be modeled as specified in this section. Case GC10a shall be the first case modeled and all other tests in this series shall be sequential revisions to a previously completed model. The base case models for each case shall be:

Case	Basis for Case
GC10a	Not Applicable
GC30a	GC30b
GC40a	GC30a

**Informative Note:** The “a”-series cases are for detailed numerical-methods programs (e.g., three-dimensional [3D] numerical models) that are either integrated within or run independently from whole-building energy simulation programs. Within the “a”-series cases, Case GC10a provides a 3D steady-state analytical solution for rectangular surface geometry (Delsante, Stokes, and Walsh 1983).<sup>A-4</sup>

**5.2.4.2.1 Case GC10a Analytical Solution Case.** Case GC10a shall be modeled as specified in this section.

**Informative Notes:**

1. **Objective of the Test Case:** Compare steady-state heat flow results for detailed 3D numerical models used independently from whole-building energy simulation programs versus an analytical solution (described in Annex B11, Section B11.2.1). Users of such detailed models are to determine appropriate inputs to match the boundary conditions and assumptions of the analytical solution, including appropriate meshing, the amount of ground that needs to be modeled, and length of simulation, etc. Attention to such modeling details is needed to obtain consistent high-quality results throughout these test cases. In other test cases where exact analytical solutions are not known—and if there is good agreement among detailed numerical models and appropriate application of the models is well documented—the detailed numerical-model results can be used as verified numerical model results. Such results provide a secondary mathematical truth standard, founded on the range of disagreement of the verified numerical-model results, for comparing results of other models typically used with whole-building energy simulation programs.
2. **Method of the Test Case:** This case calculates steady-state heat flow using fundamental 3D heat

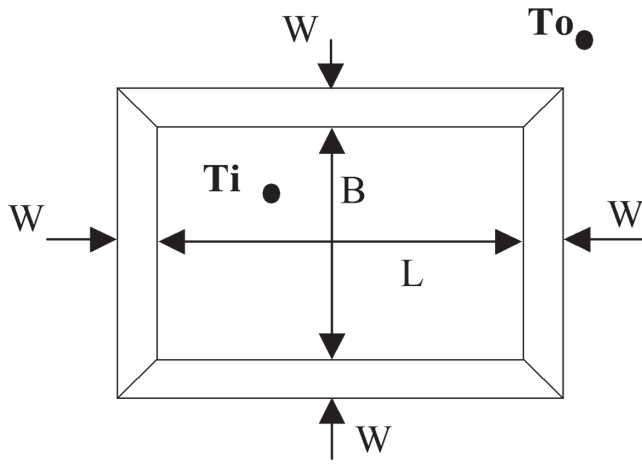

FIGURE 5-12 Case GC10a plan view of the floor geometry.

TABLE 5-29 Case GC10a Input Parameters

Test Parameters	SI	I-P
Slab length (L)	12 m	39.37 ft
Slab width (B)	12 m	39.37 ft
Perimeter surface boundary width (W)	0.24 m	0.7874 ft
Interior (slab) surface temperature ( $T_i$ )	30°C	86°F
Exterior (ground) surface temperature ( $T_o$ )	10°C	50°F
Thermal conductivity of the slab and soil	1.9 W/(m·K)	1.098 Btu/(h·ft·°F)

transfer analysis of a semi-infinite solid.<sup>A-4, A-8</sup> Figure 5-12 shows the boundary conditions at the upper surface of the semi-infinite solid and describes a rectangular floor surface bounded by a concentrically rectangular perimeter surface of finite width that separates the rectangular floor surface from the exterior ground surface. The concentrically rectangular surface may also be thought of as the base of a wall that separates the interior floor surface from the exterior ground surface. Required boundary conditions may limit the number of models that can run this test case. It is recommended to check sensitivity to mesh detail, length of simulation, amount of ground modeled, convergence tolerance, etc., and demonstrate that the model is at a level of detail where including further detail yields negligible sensitivity to results.

#### 5.2.4.2.1.1 Geometry and General Description.

Geometry shall be modeled as described in Figure 5-12. Parameters related to Figure 5-12 and other input parameters

shall be modeled as specified in Table 5-29. Boundary conditions and assumptions shall be as follows:

- Interior floor surface temperature ( $T_i$ ) shall be constant and everywhere equal.
- Exterior ground surface temperature ( $T_o$ ) shall be constant and everywhere equal.
- Linear variation between  $T_i$  and  $T_o$  over a perimeter surface boundary of finite width ( $W$ ) shall be imposed only at the surface of the ground. **Informative Note:** This avoids discontinuity at the interior/exterior perimeter boundary.
- The ground surface shall be a semi-infinite solid that extends outward infinitely in all horizontal directions from the perimeter surface boundary defined in Figure 5-12 and the ground shall extend infinitely downward from all points on the infinite horizontal surface (including from the surfaces of Figure 5-12 and beyond).
- Deep-ground boundary condition at infinite soil depth =  $T_o$ .
- Thermal conductivities of slab and soil shall be equal.
- There shall be no radiative exchange.

#### 5.2.4.2.1.2 Modeling Precision

**5.2.4.2.1.2.1 Simulation Duration.** The simulation shall be run until there is  $\leq 0.1\%$  variation between the floor slab conduction for the last hour of the last year of the simulation and the last hour of the preceding year of the simulation. If the software being tested is not capable of this, the simulation duration shall be for as long as the software being tested allows.

#### Informative Notes:

- Thermal Node Mesh:** It is recommended to demonstrate that the current level of modeling detail yields negligible ( $\leq 0.1\%$ ) change in results versus a lesser level of detail; examine the effects of shallower deep-ground boundary, shorter far-field boundary distance, and less detailed mesh (if applicable). For ground depth and far-field length variations, it is recommended to increase the number of mesh nodes proportionally to the increase in soil volume being modeled.
- Convergence Tolerance:** If the software being tested allows user specification of convergence tolerance, it is recommended to demonstrate that the current level of heat-flow or temperature convergence tolerance yields negligible ( $\leq 0.1\%$ ) change in results versus the next finer convergence tolerance.
- Verified Numerical Model Precision:** For development of verified numerical model results presented in Annex B8, Section B8.2, the model developers documented their model precision work in the originating research. For best results, users running the “a”-series cases should review Appendices II-A, II-B, and II-C of the originating research report,<sup>A-7</sup> and should apply appropriate modeling precision techniques documented there.

**5.2.4.2.1.3 Output Requirements.** Output shall be provided in accordance with Section 6.2.2.3.

**5.2.4.2.2 Case GC30a—"a" Series Steady-State Base Case with Direct Input of Surface Temperatures.** Case GC30a shall be modeled as specified in this section.

**Informative Notes:**

1. **Objective of the Test Case:** Compare steady-state heat flow results from detailed numerical models to each other. Compare whole-building simulation programs (if possible) versus verified numerical-model results. Constant temperature surface boundary conditions may limit the number of models that can run this case.
2. **Method of the Test Case:** This case drives floor conduction based on the direct-input temperature difference between the interior surface of the floor slab and the exterior surface of the ground (and deep-ground boundary condition). This case is similar to Case GC10a but uses an adiabatic wall/ground interface boundary (see Figure 5-8 [Section 5.2.4.1.1.1]). The adiabatic wall/ground interface boundary replaces the linearly varying temperature perimeter surface boundary of Case GC10a. Soil and far-field boundary conditions are also described. Comparison of GC30a versus GC10a (GC30a–GC10a) checks the sensitivity to perimeter surface boundary conditions for an adiabatic versus a linearly varying temperature condition. It is recommended to check sensitivity (if applicable) to mesh detail, length of simulation, amount of ground modeled, convergence tolerance, etc., and demonstrate that the modeling is at a level of detail where including further detail yields negligible sensitivity to results.

**5.2.4.2.2.1 Input Specification.** This case shall be modeled exactly as Case GC30b except for the following changes:

- a. **Soil and Slab Thermal Properties and Boundary Conditions.** Surface temperatures and soil geometry shall be modeled as given in Table 5-30.

$T_i$  and  $T_o$  shall be applied directly to the surfaces and are constant and everywhere equal.

For programs that cannot directly input surface temperatures but are capable of inputting very high surface coefficients ( $h$ ),  $h \geq 5000 \text{ W}/(\text{m}^2\cdot\text{K})$  (881 Btu/[h·ft<sup>2</sup>·°F]) shall be used, applying the greatest value allowed by the program being tested that allows for a stable simulation. If the program being tested does not allow input of  $h \geq 5000 \text{ W}/(\text{m}^2\cdot\text{K})$  (881 Btu/[h·ft<sup>2</sup>·°F]) but does allow input of  $h > 100 \text{ W}/(\text{m}^2\cdot\text{K})$  (17.6 Btu/[h·ft<sup>2</sup>·°F]), apply the greatest value allowed by the program being tested. For programs that do not allow direct input of surface temperatures and do not allow convective surface coefficients greater than  $100 \text{ W}/(\text{m}^2\cdot\text{K})$  (17.6 Btu/[h·ft<sup>2</sup>·°F]), Case GC30b shall be run instead of Case GC30a. **Informative Note:** Sensitivity tests indicate that a constant/uniform surface temperature can be mimicked by setting zone and ambient air temperatures to  $T_i$  and  $T_o$  and applying  $h \geq 5000 \text{ W}/(\text{m}^2\cdot\text{K})$  (881

**TABLE 5-30 Case GC30a Input Parameters**

Test Parameters	SI	I-P
Interior slab surface temperature ( $T_i$ )	30°C	86°F
Exterior ground surface temperature ( $T_o$ )	10°C	50°F
Deep-ground boundary depth ( $E$ )	30 m	98.43 ft
Far field boundary distance ( $F$ )	20 m	65.62 ft

Btu/[h·ft<sup>2</sup>·°F]). Be aware that very high surface coefficients may cause some programs to become unstable.

- b. **Above Grade Construction.** If the model being tested allows direct input of surface temperatures and direct output of resulting floor conduction, only the floor slab shall be modeled, and the above-grade construction for Case GC30b (see Section 5.2.4.1.1.3) shall not be applied.
- c. **Weather Data.** The constant temperature TMY2-format weather data provided with the following file, included on the accompanying electronic media, shall be used: GC30a.TM2.

If the program does not utilize site data from the weather data file, the site parameters provided in normative Annex A1, Section A1.1.2 shall be used.

- d. **Mechanical System.** If the model being tested applies direct input of interior slab surface temperature and a building zone is not modeled, the mechanical system of Case GC30b (see Section 5.2.4.1.1.5) shall not be applied, and the remainder of this paragraph shall be ignored (skip to next Section 5.2.4.2.2.2). If a building zone is modeled, the heating system capacity shall be large enough to maintain the zone air temperature setpoint. **Informative Note:** For example, 1000 kW (3412 kBtu/h).

**5.2.4.2.2.2 Output Requirements.** Output shall be provided in accordance with Section 6.2.2.1. **Informative Note:** Note the exception for Case GC30a in Section 6.2.2.1.1.1.

**5.2.4.2.3 Case GC40a—Harmonic Variation of Direct-Input Exterior Surface Temperature.** Case GC40a shall be modeled as specified in this section.

**Informative Notes:**

1. **Objective of the Test Case:** Compare heat flow results for approximate steady-periodic (harmonic) variation of exterior ground surface temperature ( $T_o$ ) from detailed numerical models to each other. Compare whole-building simulation programs (if possible) to verified numerical-model results. Analyze the phase shift between variations of heat flow and  $T_o$ . Direct-input surface temperature boundary conditions may limit the number of models that can run this case.
2. **Method of the Test Case:** This case is similar to Case GC30a but uses harmonically varying  $T_o$  as input as  $T_o$ . Hourly TMY2-format weather data are provided for approximating a sinusoidal annual cycle of varying daily average temperature with sinusoidal diurnal temperature cycle overlaid (a high-frequency cycle overlaid on a



low-frequency cycle). Comparison of GC40a versus GC30a (GC40a–GC30a) annual hourly average floor conduction checks the sensitivity of average floor heat loss of the harmonic condition versus the steady-state condition. It is recommended to check sensitivity (if applicable) to mesh detail, length of simulation, amount of ground modeled, convergence tolerance, etc., and demonstrate that the modeling is at a level of detail where including further detail yields negligible sensitivity to results.

**5.2.4.2.3.1 Input Specification.** This case is exactly as Case GC30a except for the following changes:

- a. **Weather Data.** The weather data provided with the following file, included on the accompanying electronic media, shall be used: GC40a.TM2.

If the program does not utilize site data from the weather data file, the site parameters provided in normative Annex A1, Section A1.1.2 shall be used.

**Informative Note:** These data are described in Annex A1, Section A1.1.2; see Section A1.1.2.1 regarding harmonically varying inputs.

- b. **Heating System Capacity.** If the model being tested applies direct input of interior slab surface temperature and a building zone is not modeled, the mechanical system of Case GC30b (see Section 5.2.4.1.1.5) shall not be applied, and the remainder of this paragraph shall be ignored (skip to next bullet item, Section 5.2.4.2.3.1[c]). If a building zone is modeled, the heating system capacity shall be set so there is at least enough capacity to maintain the zone air temperature setpoint during the peak heating-load hour.

- c. **Simulation Duration.** The simulation shall be run until there is  $\leq 0.1\%$  variation between the annual floor slab conduction for the last year of the simulation and the preceding year of the simulation. If the software being tested is not capable of this, the simulation duration shall be for as long as the software being tested is capable of running.

**5.2.4.2.3.2 Output Requirements.** Output shall be provided in accordance with Section 6.2.2.2. **Informative Note:** Note the Case GC40a exception in Section 6.2.2.2.1.

**5.2.4.3 “c”-Series Cases.** The “c”-series cases shall be modeled as specified in this section. Case GC30c shall be the first modeled, and all other tests in this series shall be sequential revisions to a previously completed model. The base case models for each case shall be:

Case	Basis for Case
GC30c	GC30b
GC40c	GC30c
GC45c	GC40c
GC55c	GC40c
GC80c	GC40c

**TABLE 5-31 Case GC30c Input Parameters**

Test Parameters	SI	I-P
Interior combined surface coefficient ( $h_{int}$ )	7.95 W/(m <sup>2</sup> ·K)	1.3999 Btu/(h·ft <sup>2</sup> ·°F)
Exterior ground surface temperature ( $T_o$ )	10°C	50°F
Far-field boundary distance ( $F$ )	8 m	26.24 ft

**Informative Note:** The “c”-series cases apply boundary conditions with a fixed interior combined surface coefficient assumption of 7.95 W/m<sup>2</sup>·K (1.3999 Btu/[h·ft<sup>2</sup>·°F]) and the exterior ground surface temperature equal to the outdoor dry-bulb temperature. These boundary conditions are compatible with the assumptions of the BASESIMP program (see Annex B11, Table B11-4).

**5.2.4.3.1 Case GC30c—“c”-Series Steady-State Base Case.** Case GC30c shall be modeled as specified in this section.

- Objective of the Test Case:** Compare whole-building simulation programs versus verified numerical-model results. The constant temperature exterior surface boundary condition may limit the number of models that can run this case.
- Method of the Test Case:** This case drives floor conduction based on the difference between the zone air temperature and  $T_o$  (and deep-ground boundary temperature). This case is similar to GC30a and GC30b but uses different boundary conditions. Comparison of GC30c versus GC30a (GC30c–GC30a) checks the sensitivity to reduced interior surface coefficient; sensitivity may also be affected (secondarily) by reduced ground depth and reduced far-field ground distance.

**5.2.4.3.1.1 Input Specification.** This case shall be modeled exactly as Case GC30b except for the following changes:

- a. **Thermal Properties and Boundary Conditions.** Interior and exterior surface boundary conditions and the amount of soil modeled (versus Case GC30b) shall be as specified in Table 5-31.

If the program being tested allows direct user input of combined interior surface coefficients, then skip the remainder of this paragraph. If the program being tested allows direct user input of convective surface coefficients but allows only automatically calculated surface IR radiative exchange, the interior convective surface coefficient shall be 7.95 W/(m<sup>2</sup>·K) (1.3999 Btu/[h·ft<sup>2</sup>·°F]) and the interior surface IR emittance shall be 0, or as low as the program being tested allows. If the program being tested does not allow direct user input of convective surface coefficients or combined surface coefficients, a value for IR emittance shall be used such that an equivalent value for interior combined surface coefficient of 7.95 W/(m<sup>2</sup>·K) (1.3999 Btu/[h·ft<sup>2</sup>·°F]) is obtained.

Exterior ground surface temperature ( $T_o$ ) shall be applied directly to the surface and shall be constant and everywhere equal.

For programs that cannot directly input  $T_o$  but are capable of inputting very high  $h_{ext}$ ,  $h_{ext} \geq 5000 \text{ W}/(\text{m}^2\cdot\text{K})$  (881 Btu/[h·ft<sup>2</sup>·°F]) shall be used, applying the greatest value that the program being tested allows for a stable simulation. If the program being tested does not allow input of  $h_{ext} \geq 5000 \text{ W}/(\text{m}^2\cdot\text{K})$  (881 Btu/[h·ft<sup>2</sup>·°F]), the greatest value allowed by the program being tested shall be used.

**Informative Note:** Sensitivity tests indicate that a constant/uniform surface temperature can be mimicked by setting  $T_o$  to  $T_o$  and applying  $h_{ext} \geq 5000 \text{ W}/(\text{m}^2\cdot\text{K})$  (881 Btu/[h·ft<sup>2</sup>·°F]). Be aware that very high surface coefficients may cause some programs to become unstable.

- b. **Weather Data.** The constant temperature TMY2-format weather data provided with the following file, included on the accompanying electronic media, shall be used: GC30a.TM2.

If the program does not utilize site data from the weather data file, the site parameters provided in normative Annex A1, Section A1.1.2 shall be used.

**5.2.4.3.1.2 Output Requirements.** Output shall be provided in accordance with Section 6.2.2.1.

**Informative Note:** Note the Case GC30c exception regarding steady-state near-surface temperature ( $T_{surf,n}$ ) results as described in Section 6.2.2.1.1.d.

**5.2.4.3.2 Case GC40c—"c"-Series Harmonic Variation of Direct-Input Exterior Surface Temperature.** Case GC40c shall be modeled as specified in this section.

**Informative Notes:**

1. **Objective of the Test Case:** Compare heat flow results for approximate steady-periodic (harmonic) variation of exterior ground surface temperature ( $T_o$ ) from whole-building simulation programs versus verified numerical-model results. Analyze the phase shift between variations of heat flow and  $T_o$ . The direct-input  $T_o$  boundary condition may limit the number of models that can run this case.
2. **Method of the Test Case:** This case is similar to Case GC30c but uses harmonically varying  $T_o$  for input as  $T_o$ . Hourly TMY2-format weather data are provided for approximating a sinusoidal annual cycle of varying daily average temperature with sinusoidal diurnal temperature cycle overlaid (a high-frequency cycle overlaid on a low-frequency cycle). Comparison of GC40c versus GC30c (GC40c–GC30c) annual hourly average floor conduction checks the sensitivity of average floor heat loss of the harmonic condition versus the steady-state condition.

**5.2.4.3.2.1 Input Specification.** This case shall be modeled exactly as Case GC30c except for the following changes:

- a. **Weather Data.** The weather data provided with the following file, included on the accompanying electronic media, shall be used: GC40a.TM2.

If the program does not utilize site data from the weather data file, the site parameters provided in normative Annex A1, Section A1.1.2 shall be used.

**Informative Note:** These data are described in Annex A1, Section A1.1.2; see Section A1.1.2.1 regarding harmonically varying inputs.

- b. **Heating System Capacity.** The heating system capacity shall be set so there is at least enough capacity to maintain the zone air temperature setpoint during the peak heating-load hour. **Informative Note:** Heating capacity may vary among the test cases. This specification for the heating capacity is repeated for harmonically varying cases where floor conduction of the verified numerical models is greater for the given case than for its designated base case.
- c. **Simulation Duration.** The simulation shall be run until there is  $\leq 0.1\%$  variation between the annual floor slab conduction for the last year of the simulation and the preceding year of the simulation. If the software being tested is not capable of this, the simulation duration shall be for as long as the software being tested is capable of running.

**5.2.4.3.2.2 Output Requirements.** Output shall be provided in accordance with Section 6.2.2.2.

**5.2.4.3.3 Case GC45c—"c"-Series Aspect Ratio.** Case GC45c shall be modeled as specified in this section.

**Informative Notes:**

1. **Objective of the Test Case:** Test the sensitivity to variation of AR in the context of steady-periodic (harmonic) variation of  $T_o$ . The AR for a given slab area directly affects the ratio of perimeter heat transfer to core heat transfer. In this context, the term *perimeter* is different from the perimeter boundary described in Case GC10a. Here, perimeter heat transfer is the heat transfer driven by the zone to ambient air temperature difference through a relatively thin layer of soil; core heat transfer is driven by the zone to deep-ground temperature difference, through a relatively thick layer of soil.
2. **Method of the Test Case:** This case is similar to Case GC40c. It uses a slab with the same surface area but a different AR. Comparison of results for GC45c versus GC40c (GC45c–GC40c) checks the sensitivity of AR. Compare heat-flow results from whole-building simulation programs to verified numerical-model results. Analyze phase shift between variations of heat flow and  $T_o$ .

**5.2.4.3.3.1 Input Specification.** This case shall be modeled exactly as Case GC40c except for the following changes:

- a. **Slab dimensions.** Slab dimensions shall be modeled as specified in Table 5-32.
- b. **Heating System Capacity.** The heating system capacity shall be set so there is at least enough capacity to maintain the zone air temperature setpoint during the peak heating-load hour.

**TABLE 5-32 Case GC45c Slab Dimensions**

Test Parameters	SI	I-P
Slab length ( <i>L</i> )	36 m	118.11 ft
Slab width ( <i>B</i> )	4 m	13.12 ft

**TABLE 5-33 Case GC55c. Deep-Ground Boundary Depth**

Test Parameters	SI	I-P
Deep-ground boundary depth ( <i>E</i> )	5 m	16.40 ft

**5.2.4.3.3.2 Output Requirements.** Output shall be provided in accordance with Section 6.2.2.2, except slab dimensions *L* and *B* from Table 5-32 shall be used.

**5.2.4.3.4 Case GC55c—“c”-Series Shallow Deep-Ground Temperature.** Case GC55c shall be modeled as specified in this section.

**Informative Notes:**

- Objective of the Test Case:** Test the sensitivity to variation of deep-ground temperature depth in the context of steady-periodic (harmonic) variation of  $T_o$ . This case is relevant for areas with a relatively shallow groundwater table, which increases the effect of core heat flow that is driven by the difference between the zone air temperature and the deep-ground temperature.
- Method of the Test Case:** This case is similar to Case GC40c but uses a shallower deep-ground boundary (heat sink) location. Comparison of results for GC55c versus GC40c (GC55c–GC40c) checks the sensitivity of deep-ground temperature depth. Compare heat-flow results from whole-building simulation programs to verified numerical-model results. Analyze phase shift between variations of heat flow and  $T_o$ .

**5.2.4.3.4.1 Input Specification.** This case shall be modeled exactly as Case GC40c except for the following changes:

- Deep-Ground Boundary Depth.** The deep-ground temperature boundary depth shall be modeled as specified in Table 5-33.
- Heating System Capacity.** The heating system capacity shall be set so there is at least enough capacity to maintain the zone air temperature setpoint during the peak heating-load hour.

**5.2.4.3.4.2 Output Requirements.** Output shall be provided in accordance with Section 6.2.2.2.

**5.2.4.3.5 Case GC80c—“c”-Series Reduced Slab and Ground Conductivity.** Case GC80c shall be modeled as specified in this section.

**Informative Notes:**

- Objective of the Test Case:** Test sensitivity to reduced slab and ground conductivity in the context of steady-periodic (harmonic) variation of  $T_o$ .

- Method of the Test Case:** This case is similar to Case GC40c but uses decreased slab and ground conductivity. Comparison of results for GC80c versus GC40c (GC80c–GC40c) checks the sensitivity of slab and ground conductivity. Compare heat-flow results from whole-building simulation programs to verified numerical-model results. Analyze phase shift between variations of heat flow and  $T_o$ .

**5.2.4.3.5.1 Input Specification.** This case shall be modeled exactly as Case GC40c except:

$$\text{Soil and slab thermal conductivity} = 0.85 \text{ W/(m}\cdot\text{K)} \\ (0.491 \text{ Btu/[h}\cdot\text{ft}\cdot\text{°F)}).$$

**5.2.4.3.5.2 Output Requirements.** Output shall be provided in accordance with Section 6.2.2.2.

**Modify Section 6.1.1 as shown.**

**6.1.1 Standard Output Reports.** The standard output reports included on the accompanying electronic media shall be used. Instructions regarding these reports are included in Annex A2. Information required for this report includes

- software name and version number;
- modeling documentation using S140outNotes.TXT on the accompanying electronic media for
  - software identifying information and operating requirements,
  - modeling methods used when alternative methods are available in the software (as specified in Section 5.1.4),
  - equivalent modeling methods used when the software does not allow direct input of specified values (as specified in Section 5.1.5),
  - nonspecified inputs (as specified in Section 5.1.6),
  - changes to source code for the purpose of running the tests, where such changes are not available in publicly released versions of the software (as specified in Section 5.1.9),
  - omitted test cases and results (as specified in Section 6.1.3), and
  - anomalous results (as specified in Section 6.1.4); and
- results for simulated cases using the following files on the accompanying electronic media:
  - Sec5-2Aout.XLS for the building thermal envelope and fabric load tests of Sections 5.2.1, 5.2.2, and 5.2.3
  - Sec5-2Bout.XLS for the ground-coupled slab-on-grade analytical verification tests of Section 5.2.4
  - Sec5-3Aout.XLS for the space-cooling equipment performance analytical verification tests of Sections 5.3.1 and 5.3.2
  - Sec5-3Bout.XLS for the space-cooling equipment performance comparative tests of Sections 5.3.3 and 5.3.4
  - Sec5-4out.XLS for the space-heating equipment performance tests of Section 5.4

For the specific output quantities required in the results report for each case, refer to the appropriate subsections of Sections 5.2, 5.3, and 5.4.

**Insert new subsection 6.2.1 for existing Envelope and Fabric Load Test and renumber existing subsections of Section 6.2 (6.2.n) as subsections of 6.2.1(6.2.1.n). All references to Section 6.2 and its subsections (6.2.n) in Standard 140-2011 will be changed to reference Section 6.2.1 and its subsections (6.2.1.n).**

**6.2 Output Requirements for Building Thermal Envelope and Fabric Load and Ground-Coupled Slab-on-Grade Tests of Section 5.2.** Required output shall be as specified in the sections below.

**6.2.1 Output Requirements for Building Thermal Envelope and Fabric Load Tests of Sections 5.2.1, 5.2.2, and 5.2.3**

**6.2.1.1 All Non-Free-Float Cases.** Required outputs for the non-free-float cases shall be as designated in Sections 6.2.1.1.1 through 6.2.1.1.5:

**Informative Note:** In this description, the term “free-float cases” refers to cases designated with FF in the case description (i.e., 600FF, 650FF, 900FF, 950FF); non-free-float cases are all the other cases described in Sections 5.2.1, 5.2.2, and 5.2.3 (Tables B1-1a and B1-1b of Annex B1 include an informative summary listing of the cases of Sections 5.2.1, 5.2.2, and 5.2.3).

**6.2.1.1.1** Annual heating load (MWh).

**6.2.1.1.2** Annual sensible cooling loads (MWh).

**6.2.1.1.3** Annual hourly integrated peak heating load (kW) with date and hour of occurrence.

**6.2.1.1.4** Annual hourly integrated peak sensible cooling load (kW) with date and hour of occurrence.

**6.2.1.1.5** All heating and cooling loads listed in Sections 6.2.1.1.1 through 6.2.1.1.4 shall be entered into the appropriate standard output report (as specified in Annex A2) as positive values ( $\geq 0$ ).

**6.2.1.2 Case 600 Only**

**6.2.1.2.1** Annual incident unshaded total solar radiation (diffuse and direct) on north, east, west, south, and horizontal surfaces ( $\text{kWh/m}^2$ ).

**6.2.1.2.2** Unshaded annual transmitted solar radiation (diffuse and direct) through south windows ( $\text{kWh/m}^2$ ). This quantity does not include radiation that is absorbed in the glass and conducted inward as heat.

**Informative Note:** This quantity may be taken as the optically transmitted solar radiation through a window that is backed by a perfectly absorbing black cavity.

**6.2.1.3 Case 610 Only**

**6.2.1.3.1** Annual transmitted solar radiation through the shaded south window with a horizontal overhang ( $\text{kWh/m}^2$ ).

**6.2.1.4 Case 620 Only**

**6.2.1.4.1** Unshaded annual transmitted solar radiation (diffuse and direct) through the west window ( $\text{kWh/m}^2$ ). This quantity does not include radiation that is absorbed in the glass and conducted inward as heat.

**Informative Note:** This quantity may be taken as the optically transmitted solar radiation through a window that is backed by a perfectly absorbing black cavity.

**6.2.1.5 Case 630 Only**

**6.2.1.5.1** Annual transmitted solar radiation through the shaded west window with horizontal overhang and vertical fins ( $\text{kWh/m}^2$ ).

**6.2.1.6 All Free-Float Cases.** Required outputs for the free-float cases shall be as designated in Sections 6.2.1.6.1 through 6.2.1.6.3.

**Informative Note:** In this description, the term “free-float cases” refers to cases designated with FF in the case description (i.e., 600FF, 650FF, 900FF, 950FF, and for just the sun zone in Case 960).

**6.2.1.6.1** Annual hourly integrated maximum zone air temperature,  $^{\circ}\text{C}$ , with date and hour of occurrence.

**6.2.1.6.2** Annual hourly integrated minimum zone air temperature,  $^{\circ}\text{C}$ , with date and hour of occurrence.

**6.2.1.6.3** Annual mean zone air temperature,  $^{\circ}\text{C}$ .

**Informative Note:** For all cases where free-float-zone air temperature output is required, the free-float-zone air temperature is for the zone air only, assuming well-mixed air with no radiant effects (i.e., equivalent to what would be obtained from an aspirated temperature sensor perfectly shielded from solar and infrared radiation).

**6.2.1.7 Case 900FF Only**

**6.2.1.7.1** Annual hourly  $1^{\circ}\text{C}$  zone air temperature bin frequencies from  $-20^{\circ}\text{C}$  to  $70^{\circ}\text{C}$ , where “bin frequency” is the number of hours a given zone air temperature has values within given bins ( $1^{\circ}\text{C}$  bin width) during the annual simulation. Zone air temperature bins are defined by an integer value of temperature as the lower bound (inclusive) of the range, the upper bound of the range being less than the next highest integer value.

**Informative Note:** For example, the zone air temperature (T) bin defined by  $20^{\circ}\text{C}$  is  $20^{\circ}\text{C} \leq T < 21^{\circ}\text{C}$ ; and similarly the bin defined by  $-2^{\circ}\text{C}$  is  $-2^{\circ}\text{C} \leq T < -1^{\circ}\text{C}$ .

**Output Example:** Output from an annual simulation (8760 hours) might indicate 400 hours when the zone air temperature (T) is  $25^{\circ}\text{C}$  ( $25^{\circ}\text{C} \leq T < 26^{\circ}\text{C}$ ) and 430 hours when the zone air temperature is  $28^{\circ}\text{C}$  ( $28^{\circ}\text{C} \leq T < 29^{\circ}\text{C}$ ), with temperatures for remaining hours distributed among other bins as appropriate.

Additional information regarding this calculation is provided in Informative Annex B12.

**6.2.1.8 Daily Hourly Output for Building Thermal Envelope and Fabric Load Tests of Sections 5.2.1 and 5.2.2.** If the program being tested is capable of producing hourly outputs, then the following hourly values for the specified days shall be provided. To produce this output, the simulation period shall be a typical annual run, as specified in Sections 5.1.7 and 5.1.8.1.

Running the simulation for only the required days specified in the output requirements shall be prohibited, because the results could contain temperature history errors. Required outputs shall be as listed for specific cases in Table 6-1.

**Revise title of Table 6-1 as shown.**

**TABLE 6-1 Daily Hourly Output Requirements for Building Thermal Envelope and Fabric Load Tests of Sections 5.2.1 and 5.2.2**

**Insert new Section 6.2.2 as shown.**

**6.2.2 Output for Ground-Coupled Slab-On-Grade Analytical Verification Tests of Section 5.2.4**

**6.2.2.1 Output Requirements for Steady State Cases: GC30b, GC60b, GC65b, GC30a, GC30c**

**6.2.2.1.1 Last Hour of Simulation Outputs.** The following outputs shall be provided for the last hour of the simulation:

- a. Conduction through the floor slab ( $q_{floor}$ ) in W or Wh/h; this is specifically conduction through the interior surface of the slab defined by dimensions  $B \times L$  in Figure 5-9 (see Section 5.2.4.1.1.1).
- b. Zone load ( $q_{zone}$ ) in W or Wh/h. If the program being tested does not have different outputs for zone load and floor conduction, the available output shall be reported where it is most appropriate and the other output left blank. **Informative Note:** For example, report the results only as floor conduction, and do not report any zone load results. Zone load outputs should only vary from floor slab conduction if the program being tested does not allow fully adiabatic above-grade walls. Models run independently of whole-building simulations may have limited output options here.
- c. Zone air temperature ( $T_{zone}$ ) (°C). **Informative Note:** This output checks the temperature that results from the given thermostat setpoint.
- d. Steady state near-surface temperatures ( $T_{surf,n}$ ) (°C) as described in Table 6-2 and Figure 6-1 except Case GC30c. The temperatures shall be for the uppermost-modeled layer of soil just below the ground surface at consistent depth. For defining coordinates, the center of the floor slab shall be designated as (0,0) as shown in Figure 6-1.

**6.2.2.1.1.1 Case GC30a Exception.** For Case GC30a, if the model being tested uses direct input of interior slab surface temperature and a building zone is not modeled, then the following results are not required:

- a. Zone load ( $q_{zone}$ ) in W or Wh/h
- b. Zone air temperature ( $T_{zone}$ ) (°C).

**6.2.2.1.2 Other Outputs.** These additional outputs shall be provided:

- a. Duration of simulation ( $t_{sim}$ ) in hours. **Informative Note:** This is the number of hours simulated (e.g., if 10 years are simulated, indicate 87,600 hours.)

**Informative Note:** Figure 6-1 represents a single quadrant of the symmetric slab/perimeter-boundary/exterior surfaces.

**6.2.2.2 Output Requirements for Harmonic Variation of Ambient Temperature Cases: GC40b, GC45b, GC50b, GC55b, GC70b, GC80b, GC40a, GC40c, GC45c, GC55c, GC80c**

**6.2.2.2.1 Last Year of Simulation Outputs.** The following outputs shall be provided for only the last full year of the simulation:

**TABLE 6-2 x and y Coordinates of Near-Surface Temperature Outputs**

Location, n	y (cm)	x (cm)	$T_{surf,n}$ (°C)
1	0	0	
2	0	433	
3	0	554	
4	0	587	
5	0	596	
6	0	600	
7	0	602	
8	0	605	
9	0	612	
10	0	619	
11	0	622	
12	0	624	
13	0	628	
14	0	640	
15	0	687	
16	0	876	
17	0	1628	
18	0	4624	
Location, n	y (cm)	x (cm)	$T_{surf,n}$ (°C)
1	0	0	
19	433	433	
20	554	554	
21	587	587	
22	596	596	
23	600	600	
24	602	602	
25	605	605	
26	612	612	
27	619	619	
28	622	622	
29	624	624	
30	628	628	
31	640	640	
32	687	687	
33	876	876	
34	1628	1628	
35	4624	4624	

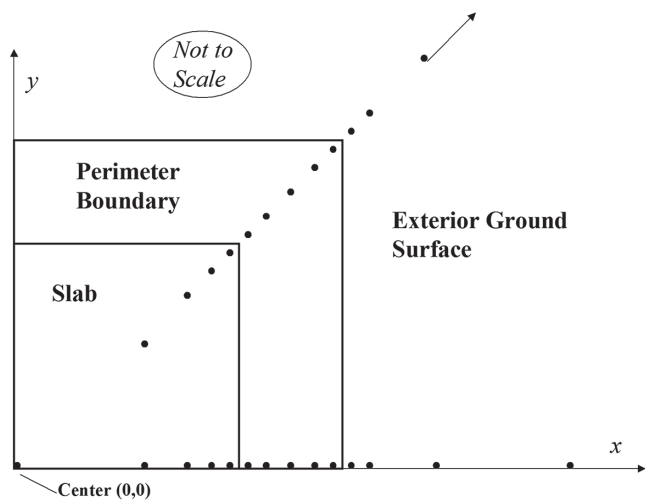

**FIGURE 6-1 Conceptual plan view of near-surface temperature outputs.**

- a. Annual total conduction through the floor slab ( $Q_{floor}$ ) (kWh/y); this is specifically conduction through the interior surface of the slab defined by dimensions  $B \times L$  in Figure 5-9 (see Section 5.2.4.1.1.1). For dimensions of  $B$  and  $L$  in cases GC45b, GC50b, and GC45c, see Tables 5-24, 5-25, and 5-32, respectively.
- b. Annual total zone load ( $Q_{zone}$ ) (kWh/y). If the program being tested does not have different outputs for zone load and floor conduction, the available output shall be reported where it is most appropriate and the other output left blank. **Informative Note:** For example, report the results only as floor conduction, and do not report any zone load results. Zone load outputs should only vary from floor slab conduction if the program being tested does not allow fully adiabatic above-grade walls. Models run independently of whole-building simulations may have limited output options here.
- c. Annual average zone temperature ( $T_{zone,mean}$ ) (°C). **Informative Note:** This output checks the temperature that results from the given thermostat setpoint.
- d. Annual hourly integrated peak floor conduction ( $q_{floor,max}$ ) (Wh/h or W) for the year and the hour of occurrence; this is specifically the peak conduction through the interior surface of the slab defined by dimensions  $B \times L$  in Figure 5-9 (see Section 5.2.4.1.1.1). For dimensions of  $B$  and  $L$  in cases GC45b, GC50b, and GC45c, see Tables 5-24, 5-25, and 5-32, respectively.
- e. Annual hourly integrated peak zone load ( $q_{zone,max}$ ) (Wh/h or W) for the year and the hour of occurrence. **Informative Note:** This output should only vary from floor slab conduction if the program being tested does not allow fully adiabatic above-grade walls.
- f. Minimum hourly ambient temperature ( $T_{ODB,min}$ ) (°C) and first hour of occurrence.
- g. Number of hours with minimum hourly  $T_{o,a}$ .

- h. For Cases GC40b, GC40a, GC40c only: Hourly floor conduction (Wh/h or W) for the entire year; this is specifically hourly conduction through the interior surface of the slab defined by dimensions  $B \times L$  in Figure 5-9 (see Section 5.2.4.1.1.1).
- i. Hourly time convention; e.g., Hour 1 = 0:00–1:00, or Hour 1 = 0:30–1:30.

**6.2.2.2.2 Other Outputs.** The following additional output shall be provided:

- a. Duration of simulation ( $t_{sim}$ ) in hours. **Informative Note:** This is the number of hours simulated, e.g., if 10 years are simulated, indicate 87,600 hours.

**6.2.2.2.2.1 Case GC40a Exception.** For case GC40a, if the model being tested applies direct input of interior slab surface temperature and a building zone is not modeled, then the following results are not required:

- a. Annual total zone load ( $Q_{zone}$ ) (kWh/y)
- b. Annual average zone temperature ( $T_{zone,mean}$ ) (°C)
- c. Annual hourly integrated peak zone load ( $q_{zone,max}$ ) (Wh/h or W) for the year, including hour of occurrence.

### 6.2.2.3 Output Requirements for Case GC10a—Analytical Solution Case

**6.2.2.3.1 Last Hour of Simulation Outputs.** The following outputs shall be provided for the last hour of the simulation:

- a. Steady-state conduction through the floor slab ( $q_{floor}$ ) in W or Wh/h; this is specifically hourly conduction through the interior surface of the slab defined by dimensions  $B \times L$  in Figure 5-12 and Table 5-29 (see Section 5.2.4.2.1.1).
- b. Steady-state near-surface temperatures ( $T_{surf,n}$ ) (°C) as described in Figure 6-1 and Table 6-2 (see Section 6.2.2.1.1.d). The temperatures shall be for the uppermost modeled layer of soil just below the ground surface at a consistent depth. For defining coordinates, the center of the floor slab shall be designated as (0,0) as shown in Figure 6-1. **Informative Note:** These outputs are for comparison with models that do not provide results precisely at the surface.
- c. Steady-state surface temperatures ( $T_{@surf,n}$ ) (°C) as described for  $T_{surf,n}$  in Figure 6-1 and Table 6-2 (see Section 6.2.2.1.1.d). For defining coordinates, the center of the floor slab is designated as (0,0) as shown in Figure 6-1. **Informative Note:** These outputs are for checking proper application of surface temperature boundary conditions.

**6.2.2.3.2 Other Outputs.** The following additional outputs shall be provided:

- a. Duration of simulation ( $t_{sim}$ ) in hours
- b. Deep-ground temperature depth ( $E$ , see Figure 5-8 [Section 5.2.4.1.1.1]).
- c. Far-field boundary distance ( $F$ , see Figure 5-8 [Section 5.2.4.1.1.1]).

Revise title and introduction of Section A1.1 as shown.

## NORMATIVE ANNEX A1 WEATHER DATA

### A1.1 Weather Data for Tests of Section 5.2

**A1.1.1 Weather Data for Building Thermal Envelope and Fabric Load Tests of Sections 5.2.1, 5.2.2, and 5.2.3.** The full-year weather data (DRYCOLD.TMY) provided with the accompanying electronic media shall be used for performing the tests called out in Sections 5.2.1, 5.2.2, and 5.2.3. Site and weather characteristics are summarized in Table A1-1a. See Section A1.5 for details about TMY weather data file format.

Revise numbering of Table A1-1 title as shown.

#### Table A 1-1a. Site and Weather Summary for DRY-COLD.TMY Weather Data Used With Building Thermal Envelope and Fabric Load Tests

Insert Section A1.1.2 and Tables A1-1b and A1-1c. Renumber Tables A1-1a, A1-1b, A1-1c (and cross references) of this addendum as Tables A1-1, A1-2 and A1-3, respectively, and renumber current Tables A1-2 through A1-13 (and cross references) as Tables A1-4 through A1-15.

**A1.1.2 Weather Data for Ground-Coupled Slab-On-Grade Analytical Verification Tests of Section 5.2.4.** The full-year weather data on the electronic media provided with this standard shall be used for performing the tests of Section 5.2.4 as assigned in Table A1-1b. Site and weather characteristics are provided in Table A1-1c. Specified weather data apply TMY2 weather data format as described in Annex A1, Section A1.6. **Informative Note:** This weather data file is based on Miami.TM2 but includes many data elements set to: 0 or approximate lower limits, approximate higher limits, or neutral (non-extreme) constant values.

**A1.1.2.1 Harmonically Varying ODB ( $T_{o,a}$ ) in Weather Files.** For weather data files GC40a.TM2, GC40b.TM2, and GC70b.TM2,  $T_{o,a}$  varies hourly according to the following formula:

$$T_{o,a} = T_{day} - T_{swingday} \times (\cos((I\text{HOUR} - I\text{LOWHOUR})/24 \times 2 \times \text{PI}))$$

where

$$T_{day} = T_{mean} - T_{swingseason} \times (\cos((IDAY - ILOWDAY)/365 \times 2 \times \text{PI}))$$

where

$T_{swingday}$  = diurnal temperature swing ( $\pm$ ) = 2°C (3.6°F), for 4°C (7.2°F) diurnal range from minimum to maximum

$I\text{HOUR}$  = the daily hour counter, from 1 to 24 with reset to 1 after end of day

$I\text{LOWHOUR}$  = hour of lowest temperature = 4, for 4th hour

$\text{PI}$  = 3.1415927 ( $\approx \pi$ ); cosine function uses radians

$T_{mean}$  = annual mean temperature = 10°C (50°F)

$T_{swingseason}$  = seasonal temperature variation ( $\pm$ ) = 6°C (10.8°F), for 12°C (21.6°F) range (minimum to maximum) of average daily temperature over the year

$IDAY$  = the day counter, from 1 to 365

$I\text{LOWDAY}$  = the day of lowest temperature = 15, for January 15.

From the above formulation,  $T_{o,a}$  varies over a range of 16°C (28.8°F): from a minimum of 2°C (35.6°F) to maximum of 18°C (64.4°F) over the year.

**A1.1.2.2 Humidity Ratio, Dew-Point Temperature, Relative Humidity, and Atmospheric Pressure.** The outdoor dew-point temperature and relative humidity shown in Table A1-1c correspond to a humidity ratio of 0.000007 kg<sub>w</sub>/kg<sub>da</sub> (lb<sub>w</sub>/lb<sub>da</sub>) at constant standard atmospheric pressure and given dry-bulb temperature, as specified in Table A1-1c. **Informative Note:** The calculation of outdoor dew-point temperature and relative humidity applies common psychrometric formulae as shown in Chapter 6 of the 2001 *ASHRAE Handbook—Fundamentals*<sup>A-2</sup> and elsewhere<sup>A-3</sup>. The calculation results in outdoor dew-point temperature equal to –56.6°C (–69.9°F) (TMY2 documentation indicates that –60°C (–76.0°F) is the lower limit for TMY2 data) and outdoor relative humidity equal to 0.09% (which rounds to 0% in the weather data). In weather data with harmonically varying ODB, atmospheric pressure and dew-point temperature were set to constant values. Relative humidity was adjusted to be consistent with other listed values; however, as TMY2 format limits the precision of listed relative humidity, it still appears as constant 0%.

**A1.1.2.3 Wind Speed.** Wind speeds for provided weather data are as shown in Table A1-1c.

**Informative Note:** Wind speeds were calculated corresponding with the three exterior surface convective coefficients specified among the test cases in Section 5.2.4. Extrapolating (see 2005 *ASHRAE Handbook—Fundamentals*, pp. 25.1)<sup>A-1</sup> equations described elsewhere<sup>A-9</sup> and assuming a ground surface roughness equivalent to that typical for brick or rough plaster, the combined radiative/convective  $h_{ext}$  coefficient can be calculated. Subtracting out the equivalent radiative portion of the combined coefficient of 4.63 W/(m<sup>2</sup>·K)<sup>A-5</sup> approximates the convective only  $h_{ext}$ . Using this calculation scheme results in the following:

- For a wind speed of 1.0 m/s (2.24 miles/h), the combined convective/radiative coefficient is 16.58 W/(m<sup>2</sup>·K) (2.92 Btu/[h·ft<sup>2</sup>·°F]), and the convective only  $h_{ext}$  is 11.95 W/(m<sup>2</sup>·K) (2.10 Btu/[h·ft<sup>2</sup>·°F]).
- For a wind speed of 19.9 m/s (44.52 miles/h), the combined radiative/convective  $h_{ext}$  is 104.47 W/(m<sup>2</sup>·K) (18.40 Btu/[h·ft<sup>2</sup>·°F]), and the convective only  $h_{ext}$  = 99.84 W/(m<sup>2</sup>·K) (17.58 Btu/[h·ft<sup>2</sup>·°F]) (rounds to 100 W/[m<sup>2</sup>·K] [17.6 Btu/[h·ft<sup>2</sup>·°F])).
- For a wind speed of 40 m/s (89.48 miles/h), the combined radiative/convective  $h_{ext}$  is 219.89 W/(m<sup>2</sup>·K) (38.72 Btu/[h·ft<sup>2</sup>·°F]), and the convective only  $h_{ext}$  = 215.26 W/(m<sup>2</sup>·K) (37.91 Btu/[h·ft<sup>2</sup>·°F]); because some whole-building energy simulation software may flag weather data val-

**TABLE A1-1b Weather Data for Ground-Coupled Slab-On-Grade Analytical Verification Tests**

<u>Data Files</u>	<u>Applicable Cases/Output</u>	<u>Sections</u>
None	GC10a	5.2.4.2.1
GC30a.TM2	GC30a, GC30c	5.2.4.2.2, 5.2.4.3.1
GC30b.TM2	GC30b, GC60b	5.2.4.1.1, 5.2.4.1.6
GC65b.TM2	GC65b	5.2.4.1.7
GC40a.TM2	GC40a, GC40c, GC45c, GC55c, GC80c	5.2.4.2.3, 5.2.4.3.2, 5.2.4.3.3, 5.2.4.3.4, 5.2.4.3.5
GC40b.TM2	GC40b, GC45b, GC50b, GC55b, GC80b	5.2.4.1.2, 5.2.4.1.3, 5.2.4.1.4, 5.2.4.1.5, 5.2.4.1.9
GC70b.TM2	GC70b	5.2.4.1.8

**TABLE A1-1c Site and Weather Summary for Ground-Coupled Slab-On-Grade Analytical Verification Tests**

<u>Weather Type</u>	<u>Artificial Conditions</u>
<u>Weather Format</u>	<u>TMY2</u>
<u>Latitude</u>	<u>25.8° north</u>
<u>Longitude (local site)</u>	<u>80.3° west</u>
<u>Altitude</u>	<u>2 m (6.6 ft)</u>
<u>Time Zone (Standard Meridian Longitude)</u>	<u>5 (75° west)</u>
<u>Site</u>	<u>Flat, unobstructed, located exactly at weather station</u>
<u>Dew-Point Temperature (constant)</u>	<u>-56.6°C (-69.9°F)<sup>a</sup></u>
<u>Humidity Ratio (constant)</u>	<u>0.000007 kg moisture/kg dry air (0.000007 lb moisture/lb dry air)</u>
<u>Global Horizontal Solar Radiation Annual Total</u>	<u>0 MJ/m<sup>2</sup> (0 kBtu/ft<sup>2</sup>)</u>
<u>Direct Normal Solar Radiation Annual Total</u>	<u>0 MJ/m<sup>2</sup> (0 kBtu/ft<sup>2</sup>)</u>
<u>Diffuse Horizontal Solar Radiation Annual Total</u>	<u>0 MJ/m<sup>2</sup> (0 kBtu/ft<sup>2</sup>)</u>
<u>Extraterrestrial Horizontal and Direct Normal Radiation</u>	<u>Unchanged from original file</u>
<u>Total and Opaque Sky Cover</u>	<u>10 tenths, implying the entire sky dome is covered by clouds to reduce exterior IR radiation exchange</u>
<u>Atmospheric Pressure</u>	<u>1013 millibars (14.696 psia)</u>
<u>Visibility</u>	<u>20 km (12.4 mi) (rough annual average for Miami and Denver)</u>
<u>Ceiling Height</u>	<u>2000 m (6562 ft) (rough annual average for Miami and Denver)</u>
<u>Present Weather</u>	<u>No rain, hail, etc.</u>
<u>Precipitable Water</u>	<u>0 mm (0 in.)</u>
<u>Aerosol Optical Depth</u>	<u>0.1 broadband turbidity (rough annual average of Miami and Denver)</u>
<u>Snow Depth</u>	<u>0 cm (0 in.) with ≥88 days since last snow fall</u>

**Quantities That Vary between Data Sets**

<u>File Name</u>	<u>Mean Ambient Dry-Bulb Temperature</u>	<u>Mean Ambient Relative Humidity</u>	<u>Constant Annual Wind Speed</u>
GC30a.TM2	10°C (50.0°F), constant	0.09%, constant <sup>a</sup>	40.0 m/s (89.48 miles/h) <sup>b</sup>
GC30b.TM2	10°C (50.0°F), constant	0.09%, constant <sup>a</sup>	19.9 m/s (44.52 miles/h) <sup>b</sup>
GC65b.TM2	10°C (50.0°F), constant	0.09%, constant <sup>a</sup>	1.0 m/s (2.24 miles/h) <sup>b</sup>
GC40a.TM2	10°C (50.0°F), harmonically varying	0.09%, harmonically varying <sup>a</sup>	40.0 m/s (89.48 miles/h) <sup>b</sup>
GC40b.TM2	10°C (50.0°F), harmonically varying	0.09%, harmonically varying <sup>a</sup>	19.9 m/s (44.52 miles/h) <sup>b</sup>
GC70b.TM2	10°C (50.0°F), harmonically varying	0.09%, harmonically varying <sup>a</sup>	1.0 m/s (2.24 miles/h) <sup>b</sup>

a. See Section A1.1.2.2.

b. See Section A1.1.2.3.



ues outside of TMY2 documented limits, a value greater than 40 m/s (89.5 miles/h) was not used (99.9 m/s [223.5 miles/h] is format limit, but 40 m/s (89.5 miles/h) is the documented limit).

**A1.1.2.4 Solar Radiation.** Solar radiation is set to 0, as specified in Table A1-1c.

*Change cross reference in last sentence of Annex A1, Section A1.5 from Section B11.3 to B11.1.3.*

**A1.5 TMY Weather Data Format.** Additional background regarding the difference between solar time and standard time is included in informative Annex B11 (Section B11.1.3).

*Modify Annex A2 as shown.*

## NORMATIVE ANNEX A2 STANDARD OUTPUT REPORTS

The standard output reports consisting of the following six ~~seven~~ forms provided with the electronic media accompanying this standard shall be used:

- a. Output Results for Cases of Sections 5.2.1, 5.2.2, and 5.2.3 (Sec5-2Aout.XLS, spreadsheet file)
- b. Output Results for Cases of Section 5.2.4 (Sec5-2Bout.XLS, spreadsheet file)
- bc. Output Results for Cases of Sections 5.3.1 and 5.3.2 (Sec5-3Aout.XLS, spreadsheet file)
- ed. Output Results for Cases of Sections 5.3.3 and 5.3.4 (Sec5-3Bout.XLS, spreadsheet file)
- de. Output Results for Cases of Section 5.4 (Sec5-4out.XLS, spreadsheet file)
- ef. Output Results for Cases of Section 7.2 (sheet 'Sec7-2out' within RESULTS7-2.XLS spreadsheet file)
- fg. Modeling Notes (S140outNotes.TXT, text file reprinted as Attachment A2.65)

For entering output results into Sec5-2Aout.XLS, Sec5-2Bout.XLS, Sec5-3Aout.XLS, Sec5-3Bout.XLS, Sec5-4out.XLS, and sheet 'Sec7-2out' within RESULTS7-2.XLS, the user shall follow the instructions provided at the top of the appropriate electronic spreadsheet file or designated sheet within the spreadsheet file. These instructions are reprinted as Attachments A2.1, A2.2, A2.3, ~~and~~ A2.4, and A2.5 respectively, within this section; instructions for 'Sec7-2out' within RESULTS7-2.XLS are not reprinted here.

For entering modeling notes into S140outNotes.TXT, the format of the examples given in Attachments A2.76 within this section shall be used. The report author shall create one modeling notes TXT document for each section of tests; e.g.,

- a. S140outNotes\_5-2A.TXT for the Class I building thermal envelope and fabric load tests of Sections 5.2.1, 5.2.2, and 5.2.3
- b. S140outNotes\_5-2B.TXT for the Class I ground-coupled slab-on-grade tests of Section 5.2.4
- bc. S140outNotes\_5-3A.TXT for the Class I space cooling equipment performance analytical verification tests of Sections 5.3.1 and 5.3.2
- ed. S140outNotes\_5-3B.TXT for the Class I space cooling equipment performance comparative tests of Sections 5.3.3 and 5.3.4

de. S140outNotes\_5-4.TXT for the Class I space heating equipment performance tests of Section 5.4.

ef. S140outNotes\_7-2.TXT for the Class II test procedures of Section 7.2.

*Renumber titles of Attachments A2.2–A2.4 as shown.*

**Attachment A2.23 Instructions for Entering Results into Sec5-3Aout.XLS**

**Attachment A2.34 Instructions for Entering Results into Sec5-3Bout.XLS**

**Attachment A2.45 Instructions for Entering Results into Sec5-4out.XLS**

*Add new Attachment A2.2 as shown.*

**Attachment A2.2 Instructions for Entering Results into Sec5-2Bout.XLS**

Sec5-2Bout.XLS OUTPUT SPREADSHEET FOR GROUND-COUPLED SLAB-ON-GRADE ANALYTICAL VERIFICATION CASES: GC10a-GC80c

### INSTRUCTIONS

1. Use specified units
2. Data entry is restricted to the following ranges:

<u>I5...I8; O5...O6; O8:</u>	<u>Tested Program Identifying Information</u>
<u>E58...H63; J58, K58:</u>	<u>Steady-State Case Outputs</u>
<u>E70...R70:</u>	<u>Harmonic Case "a"-Series Outputs</u>
<u>E71...R76:</u>	<u>Harmonic Case "b"-Series Outputs</u>
<u>E77...R80:</u>	<u>Harmonic Case "c"-Series Outputs</u>
<u>G86...K103; G105...K122:</u>	<u>Steady-State Near-Surface Temperature Outputs</u>
<u>M86...M103; M105...M122:</u>	<u>GC10a At-Surface Temperature Outputs</u>
<u>G126:</u>	<u>Hourly Time Convention</u>
<u>E131...G8890:</u>	<u>Hourly Floor Conduction Outputs</u>

3. Annual sums and means are values for the entire final year of the multiyear simulation. Similarly, annual maxima, and minima are values that occur for the final year of the entire multiyear simulation.
4. Output terminology is defined in the output section of the specification for each case, where applicable.
5. Format dates using the appropriate two-digit date followed by a three-letter month code and two-digit hour code (24-hour clock) as shown below.

<u>MONTH</u>	<u>CODE</u>
<u>JANUARY</u>	<u>Jan</u>
<u>FEBRUARY</u>	<u>Feb</u>
<u>MARCH</u>	<u>Mar</u>
<u>APRIL</u>	<u>Apr</u>
<u>MAY</u>	<u>May</u>
<u>JUNE</u>	<u>Jun</u>
<u>JULY</u>	<u>Jul</u>
<u>AUGUST</u>	<u>Aug</u>
<u>SEPTEMBER</u>	<u>Sep</u>
<u>OCTOBER</u>	<u>Oct</u>
<u>NOVEMBER</u>	<u>Nov</u>
<u>DECEMBER</u>	<u>Dec</u>

For example, a maximum value occurring on August 16 during the 15th hour interval (2:00 p.m. to 3:00 p.m.), shall be input as:

<u>Date</u>	<u>Hour</u>
<u>16-Aug</u>	<u>15</u>

*Renumber title of normative Attachment A2.5, and revise as shown. S140outNotes.TXT is updated as shown. The updated version of this file is included with \Sec5-2AFiles\Normative Materials and \Sec5-2BFiles\Normative Materials files and will replace the current file in the other Sec5-n\Normative Materials files.*

## **Attachment A2.56—Standard 140 Output Form (S140outNotes.TXT)—Modeling Notes**

### **MODELING NOTES FOR ASHRAE STANDARD 140 INTRODUCTION**

This document shall include supplemental information about the ASHRAE Standard 140 tests performed. One S140outNotes document shall be provided for each set of tests (e.g., one for the building thermal and fabric load tests of Sections 5.2.1, 5.2.2, and 5.2.3; one for the space cooling equipment analytical verification tests of Sections 5.3.1 and 5.3.2; etc.) [ . . . ]

*Renumber title of informative Attachment A2.6, and revise as shown. S140outNotes\_Examples.TXT is updated as shown. The updated version of this file is included with \Sec5-2AFiles\Informative Materials and \Sec5-2BFiles\Informative Materials files and will replace the current file in the other Sec5-n\Informative Materials files*

## **INFORMATIVE ATTACHMENT A2.67—EXAMPLES OF MODELING NOTES**

### **MODELING NOTES FOR ASHRAE STANDARD 140—EXAMPLES**

#### **OVERVIEW**

This document contains examples of modeling notes entered in the S140outNotes\_Sec5-x.TXT file. Examples are provided to guide in filling out the S140outNotes\_Sec5-x.TXT file.

Note that in this file, sample notes refer to different sections of Standard 140. In an actual S140outNotes\_Sec5-x.TXT file the notes would only address one set of tests within Standard 140 (e.g., the building thermal and fabric load tests of Sections 5.2.1, 5.2.2, and 5.2.3).

#### **INTRODUCTION**

This document shall include supplemental information about the ASHRAE Standard 140 tests performed. One S140outNotes document shall be provided for each set of tests (e.g., one for the building thermal and fabric load tests of Sections 5.2.1, 5.2.2, and 5.2.3; one for the space cooling equipment analytical verification tests of Sections 5.3.1 and 5.3.2; etc.)

#### **B. REPORT BLOCK FOR ALTERNATIVE MODELING METHODS**

[ . . . ]

*Note 1:* Convective Heat Transfer and Radiative Exchange Related to Both Interior and Exterior Surfaces (Sections 5-2 5.2.1, 5.2.2, and 5.2.3)

[ . . . ]

*Note 2:* Interior Transmitted Solar Radiation Distribution (Sections 5-2 5.2.1, 5.2.2, and 5.2.3)

[ . . . ]

*Note 3:* Thermal Behavior of Windows (Sections 5-2 5.2.1, 5.2.2, and 5.2.3)

[ . . . ]

#### **C. REPORT BLOCK FOR EQUIVALENT MODELING METHODS**

[ . . . ]

*Note 1:* Thermal Decoupling of Floor from Ground (Section 5-2 5.2.1)

[ . . . ]

*Note 2:* Thermostat Control and Equipment Capacity (Section 5-2 5.2.1)

[ . . . ]

#### **E. REPORT BLOCK FOR OMITTED TEST CASES AND RESULTS**

[ . . . ]

**Note 1:** Light Weight Test Cases (Sections ~~5-2~~ 5.2.1, 5.2.2, and 5.2.3)

[...]

**Note 2:** Case 960- Sunspace, All Results (Section ~~5-2~~ 5.2.2)

[...]

*Add Table B1-1c and B1-1d, and revise introductory text as shown.*

## INFORMATIVE ANNEX B1 TABULAR SUMMARY OF TEST CASES

Tables B1-1a and B1-1b include a tabular summary of the Class I building thermal envelope and fabric load test cases described in Sections 5.2.1, 5.2.2, and 5.2.3, in SI units only. Tables B1-1c and B1-1d include a tabular summary of the Class I ground-coupled slab-on-grade analytical verification test cases described in Section 5.2.4, in SI units only. Tables B1-2a and B1-2b include a tabular summary of the Space-Cooling Equipment Performance Analytical Verification Test Cases described in Sections 5.3.1 and 5.3.2, in SI and I-P units, respectively. Table B1-3 includes a tabular summary of the Space-Cooling Equipment Performance Comparative Test Cases described in Sections 5.3.3 and 5.3.4, in SI units only. Table B1-4 summarizes the Space-Heating Equipment test cases described in Section 5.4, in SI units only. Table B1-5 summarizes the Class II building thermal envelope and fabric load tests described in Section 7.2, in I-P units only.

### Nomenclature

Abbreviations and symbols used in Tables B1-1a, B1-1b, B1-2a, B1-2b, B1-3, and B1-4 are listed below. Abbreviations used for Tables B1-1c, B1-1d, and B1-5 are listed with those that tables.

*Revise text as shown.*

## INFORMATIVE ANNEX B2 ABOUT TYPICAL METEOROLOGICAL YEAR (TMY) WEATHER DATA

TMY data are used in Standard 140, Sections 5.2.1, 5.2.2, and 5.2.3 for the following reasons:

- ~~For Section 5.2,~~ The original research that is the foundation of Standard 140, IEA BESTEST, was performed by the National Renewable Energy Laboratory in collaboration with the International Energy Agency.<sup>3</sup> The underlying research used in this standard began in 1990 and was completed in 1993. At that time, TMY data represented the state-of-the-art for hourly weather data.

*Update Section 5.2 referencing in Informative Annexes B3, B4, B5, and B7 as shown.*

### B3.1 Adjustments for ~~Section 5.2~~ Test Cases of Sections 5.2.1, 5.2.2, and 5.2.3.

### B4.2 Exterior Surface Coefficients for ~~Section 5.2~~ Test Cases of Sections 5.2.1, 5.2.2, and 5.2.3.

**B5.2 Tabulation for ~~Section 5.2~~ Test Cases of Sections 5.2.1, 5.2.2, and 5.2.3.** For the test cases of Sections 5.2.1, 5.2.2, and 5.2.3, the parameters of Equation B5-1 are as follows:

**TABLE B5-1 Disaggregation of Film Coefficients Versus Surface Infrared Emittance for Various Surface Types Related to ~~Section 5.2~~ Tests of Sections 5.2.1, 5.2.2, and 5.2.3 (SI Units)**

### B7.1 Solar Fraction Approximation Algorithm for ~~Section 5.2~~ Test Cases of Sections 5.2.1, 5.2.2, and 5.2.3.

*Revise Informative Annex B8 as shown below. Only text necessary for revising changes is shown.*

## INFORMATIVE ANNEX B8 EXAMPLE RESULTS FOR BUILDING THERMAL ENVELOPE AND FABRIC LOAD AND GROUND- COUPLED SLAB-ON-GRADE TESTS OF SECTION 5.2

Example results from various detailed building energy simulation programs that applied the tests of Section 5.2 are presented here in tabular and graphic form in the electronic media provided with this standard; these also include the analytical solution and verified numerical model results for the ground-coupled slab-on-grade cases of Section 5.2.4. These results can be used for a comparison with the software being tested. Alternatively, a user can run a number of different programs through this standard method of test or generate their own detailed numerical model results and draw comparisons from those results independently or in conjunction with the results listed here. In either case, when making comparisons, the user should employ the diagnostic logic presented in informative Annex B9, Section B9.4.

[...]

**B8.1 Building Thermal Envelope and Fabric Load Tests of Sections 5.2.1, 5.2.2, and 5.2.3.** Example results are included in the file RESULTS5-2A.PDF on the electronic media accompanying this standard. Nomenclature used in the tables and figures are defined in Section B8.1.1,<sup>2</sup> and listings of the tables and figures are provided in Section B8.1.2.<sup>3</sup>

For the convenience of users who wish to plot or tabulate their results along with the example results, the example results have been included with the file RESULTS5-2A.XLS on the electronic media provided with this standard. Section B8.1.1,<sup>2</sup> Nomenclature and B8.1.2,<sup>3</sup> formatted table and figure listings apply to this file as well. Further documentation regarding RESULTS5-2A.XLS has been included with the file and is printed out in informative Annex B10, Section B10.1, for convenience.

For a summary of how example results were developed, see Informative Annex B11, Section B11.1. For more detailed information about the example results, see IEA BESTEST.<sup>3</sup>

**TABLE B1-1c Ground-Coupled Slab-On-Grade Analytical Verification "a"-Series and "b"-Series Cases**

Case	Description/Test	Slab		Ground		Far-Field Bound <sup>b</sup> (m)	Cond. (W/mK)	Comments
		Dimen. (m x m)	h,int (W/m <sup>2</sup> K)	h,ext (W/m <sup>2</sup> K)	Depth (m)			
<b>Analytical Verification Tests</b>								
GC10a	Analytical Base Case Original Delsante et al. (1983)  Rectangular floor slab, steady-state, 3-d conduction	12 x 12	const T <sup>3</sup>	const T <sup>3</sup>	infinite	infinite	1.9	Analytical verification of detailed numerical-methods models, including set up of node meshing and boundary conditions. <i>Boundary Conditions:</i> constant temperature floor (Ti) and exterior ground (To) surfaces; linear dT across slab perimeter surface boundary <i>Other Inputs:</i> 24 cm perimeter boundary width, To = 10°C, Ti = 30°C, suppress all other modes of heat transfer.
<b>Comparative Tests</b>								
GC30a	Comparative Base Case for "a"-series	12 x 12	const T <sup>3</sup>	const T <sup>3</sup>	30	20	1.9	<i>Boundary Conditions:</i> slab perimeter surface is adiabatic GC30a-GC10a tests adiabatic versus linear dT slab perimeter surface b.c.
GC30b	Comparative Base Case for "b"-series	12 x 12	100	100	15	15	1.9	Most robust version of GC30a possible for EnergyPlus and SUNREL-GC <i>Inputs:</i> To,a = 10°C, Ti,a = 30°C. GC30b-GC30a tests h = 100 versus direct T <sup>3</sup>
GC40a	Harmonic Variation	12 x 12	direct T <sup>3</sup>	direct T <sup>3</sup>	30	20	1.9	Annual "harmonic" variation of To or To,a: mean=10°C, low=2°C, high=18°C GC40 tests phase shift of varying q versus varying To
GC40b	Harmonic Variation	12 x 12	100	100	15	15	1.9	GC40-GC30 tests annual mean q for varying versus steady To
GC45b	Aspect Ratio (AR)	36 x 4	100	100	15	15	1.9	GC45b-GC40b tests aspect ratio, high perimeter heat transfer fraction
GC50b	Large Slab	80 x 80	100	100	15	15	1.9	GC50b-GC40b tests large slab, high core heat transfer fraction
GC55b	Shallow Deep Ground Temp.	12 x 12	100	100	2	15	1.9	GC55b-GC40b tests shallow deep ground temperature, high core heat transfer fraction
GC60b	h,int	12 x 12	7.95	100	15	15	1.9	GC60b-GC30b tests h,int and resulting floor surface Temp. distribution
GC65b	h,int and h,ext	12 x 12	7.95	11.95	15	15	1.9	GC65b-GC60b tests h,ext and resulting ground surface Temp. distribution GC65b-GC30b tests combined effects of h,int and h,ext
GC70b	Harmonic h,int and h,ext	12 x 12	7.95	11.95	15	15	1.9	GC70b-GC40b tests combined effects of h,int and h,ext in dynamic context GC70b-GC65b tests annual mean q for varying versus steady To
GC80b	Ground Conductivity	12 x 12	100	100	15	15	0.5	GC80b-GC40b tests ground conductivity
<b>Abbreviations:</b>								
"b.c." = boundary condition								
"Cond." = slab & soil conductivity								
"const T <sup>3</sup> " = direct input constant temperature								
"Dimen." = dimension								
<b>Notes:</b> <sup>a</sup> For models that require air temperature inputs (i.e., that do not allow direct input of surface temperatures), convective surface coefficients are effectively infinite.								
<sup>b</sup> Distance from slab edge.								
<sup>c</sup> GC30c-GC30a also includes minor difference in amount of soil modeled.								

**TABLE B1-1d Ground-Coupled Slab-On-Grade Analytical Verification "c"-Series Cases**

Case	Description/Test	Dynamic	Slab		Ground		Far-Field Bound <sup>b</sup> (m)	Cond. (W/mK)	Comments
			Dimen. (m x m)	h,int (W/m <sup>2</sup> K)	h,ext (W/m <sup>2</sup> K)	Depth (m)			
GC30c	Comparative Base Case for "c"-series	steady state	12 x 12	7.95	const T <sup>3</sup>	15	8	1.9	Most robust version of GC30 that can be done by BASESIMP Inputs: To = 10°C, Ti,a = 30°C. GC30c-GC30a tests reduced h,int = 7.95 W/(m <sup>2</sup> K) versus direct T <sup>c</sup>
GC40c	Harmonic Variation	harmonic	12 x 12	7.95	direct T <sup>3</sup>	15	8	1.9	GC40c tests phase shift of varying q versus varying To GC40c-GC30c tests annual mean q for varying versus steady To
GC45c	Aspect Ratio (AR)	harmonic	36 x 4	7.95	direct T <sup>3</sup>	15	8	1.9	GC45c-GC40c tests aspect ratio, high perimeter heat transfer fraction
GC55c	Shallow Deep Ground Temp.	harmonic	12 x 12	7.95	direct T <sup>3</sup>	5	8	1.9	GC55c-GC40c tests shallow deep ground temperature, high core heat transfer fraction
GC80c	Ground Conductivity	harmonic	12 x 12	7.95	direct T <sup>3</sup>	15	8	0.85	GC80c-GC40c tests ground conductivity
<b>Abbreviations:</b>									
"Cond." = slab and soil conductivity									
"const T" = direct input constant temperature									
"Dimen." = dimension									
"direct T" = direct input temperature (varies hourly)									
"h,ext" = exterior surface convective coefficient									
"h,int" = interior surface convective coefficient									
"q" = heat flow through floor slab									
"Temp." = temperature									
"Ti,a" = zone air temperature									
"To" = exterior ground surface temperature									
<b>Notes:</b>									
<sup>a</sup> For models that require air temperature inputs (which do not allow direct input of surface temperatures), convective surface coefficients are effectively infinite.									
<sup>b</sup> Distance from slab edge.									
<sup>c</sup> GC30c-GC30a also includes minor difference in amount of soil modeled.									

**Revise Nomenclature header number and title as shown**

**B8.2B8.1.1 Nomenclature for RESULTS5-2A.PDF and RESULTS5-2A.XLS.**

**Revise following subsection as shown.**

**B8.1.2.3 Listing of Tables and Figures.** Tables B8-1 and B8-2 list example results tables and figures included in the RESULTS5-2A.PDF and RESULTS5-2A.XLS files. The RESULTS5-2A.PDF file presents these tables and figures sequentially. The Sheet and Cell Range columns are only applicable to the RESULTS5-2A.XLS file.

**Revise table header as shown; table content does not change.**

**TABLE B8-2 B8.1.23 Example Result RESULTS5-2A.XLS Figures**

**Insert new Section B8.2 as shown.**

**B8.2 Ground-Coupled Slab-On-Grade Analytical Verification Tests of Section 5.2.4.** Example results for the ground-coupled slab-on-grade tests of Section 5.2.4 are included with the file RESULTS5-2B.XLSX on the electronic media provided with this standard. Section B8.2.4 includes a listing of tables and graphs within RESULTS5-2B.XLSX, along with navigation instructions. Complete documentation regarding RESULTS5-2B.XLSX is included in the file

RESULTS5-2B.DOC and is printed out in informative Annex B10, Section B10.2. For the convenience of users who wish to tabulate their results along with the example results, RESULTS5-2B.XLSX provides a method for incorporating user results. For a summary of how example results were developed, see Informative Annex B11, Section B11.2. More detailed information about the example results is included in the originating NREL/IEA research report.<sup>A-7</sup>

**B8.2.1 Importance of Analytical Solution and Verified Numerical Model Results.** The ground-coupled slab-on-grade test cases of Section 5.2.4 use the results of verified numerical models for ground-coupled heat transfer as a secondary mathematical truth standard, to which results from models typically used with whole-building energy simulation software can be compared. The logic of the cases may be summarized as follows:

- a. Identify or develop exact analytical solutions that may be used as mathematical truth standards for testing detailed numerical models using parameters and simplifying assumptions of the analytical solution.
- b. Apply a numerical solutions process that demonstrates convergence in the space and time domains for the analytical-solution test cases and additional test cases where numerical models are applied.
- c. Once validated against the analytical solutions, use the numerical models to develop reference results for test cases that progress toward more realistic (less idealized) conditions and that do not have exact analytical solutions.

**TABLE B8-1 B8.1.23 Example Result RESULTS5-2A.XLS Tables**

Table	Description	Sheet	Cell Range
Table B8-1	Annual Heating Loads	Tables 1	AB7–P47
Table B8-2	Annual Sensible Cooling Loads		AB48–P89
Table B8-3	Annual Hourly Integrated Peak Heating Loads		AB7–AH47
Table B8-4	Annual Hourly Integrated Peak Sensible Cooling Loads	Tables 2	AB48–AH88
Table B8-5	Free-Float Temperature Output		AB89–AH118
Table B8-6	Low Mass Basic Sensitivity Tests	Tables 3	AB7–P39
Table B8-7	High Mass Basic Sensitivity Tests		AB41–P81
Table B8-8	Low Mass In-Depth (Cases 195 thru 320) Sensitivity Tests	Tables 4	AB7–P78
Table B8-9	Low Mass In-Depth (Cases 395 thru 440) Sensitivity Tests	Tables 5	AB7–P45
Table B8-10	High Mass Basic and In-Depth Sensitivity Tests.		AB47–P91
Table B8-11	Annual Transmissivity Coefficient of Windows		AB7–O14
Table B8-12	Annual Shading Coefficient of Window Shading Devices: Overhangs & Fins		AB16–O23
Table B8-13	Case 600 Annual Incident Solar Radiation (kWh/m <sup>2</sup> )	Tables 6	AB25–O34
Table B8-14	Case 600 Annual Transmitted Solar Radiation—Unshaded (kWh/m <sup>2</sup> )		AB36–O42
Table B8-15	Case 600 Annual Transmitted Solar Radiation—Shaded (kWh/m <sup>2</sup> )		AB44–O50

- d. Check the numerical models by carefully comparing their results to each other while developing the more realistic cases, and make corrections as needed.
- e. Good agreement for the set of numerical models versus the analytical solution—and versus each other for subsequent test cases—verifies them as a secondary mathematical truth standard based on the range of disagreement among their results.
- f. Use the verified numerical-model results as reference results for testing other models that have been incorporated into whole-building simulation computer programs.

This approach represents an important methodological advance to extend the analytical verification method beyond the constraints inherent in classical analytical solutions. It allows a secondary mathematical truth standard to be developed in the form of a set of stand-alone detailed numerical models. Once verified against all available classical analytical solutions and compared with each other for cases that do not have exact analytical solutions, the set of verified numerical models can be used together to test other models as implemented in whole-building simulation programs. This allows for greater diagnostic capability than the purely comparative method, and it allows somewhat more realistic boundary conditions to be used in the test cases than are possible with pure analytical solutions.

A characteristic difference between the Section B8.1 results for the building thermal envelope and fabric load tests of Sections 5.2.1, 5.2.2, and 5.2.3 versus the Section B8.2 results for the ground-coupled slab-on-grade tests of Section 5.2.4 is that the results of Section B8.2 include verified numerical model results (as described above) and an analytical solution result. In general, it is difficult to develop worthwhile test cases that can be solved analytically, but such solutions are extremely useful when possible. Analytical solutions (or quasi-analytical solutions for some cases of other sections) represent a mathematical truth standard; that is, given the underlying physical assumptions in the case definitions, there is a mathematically correct solution for each case. The analytical solution and verified numerical model results presented for the ground-coupled slab-on-grade cases represent mathematical and secondary mathematical truth standards, respectively. This allows identification of bugs in the software that would not otherwise be apparent from comparing software only to other software, and therefore improves the diagnostic capabilities of the test procedure.

It is important to understand the difference between a mathematical truth standard or secondary mathematical truth standard and an absolute truth standard. In the former, we only test the solution process for a model, not the appropriateness of the solution; that is, we accept the given underlying physical assumptions while recognizing that these assumptions represent a simplification of physical reality. An approximate truth standard from an experiment tests both the solution process and appropriateness of the model within experimental uncertainty. The ultimate or “absolute” validation truth standard would be comparison of simulation results

with a perfectly performed empirical experiment, with all simulation inputs perfectly defined. In reality, an experiment is performed and the experimental object is specified within some acceptable range of uncertainty. Such experiments are possible, but expensive. We recommend developing a set of empirical validation experiments in the future.

Further discussion of how the analytical solution was applied and developed is included, respectively, in Section B11.2.1 and the preceding developmental work by Commonwealth Scientific and Industrial Research Organization (CSIRO).<sup>A-4</sup> Further discussion of how the verified numerical model results were developed is included in informative Annex B11, Section B11.2.2 of this standard, and Part II, Section 2.9 (Appendices II-A, II-B, and II-C) of the originating NREL/IEA report.<sup>A-7</sup>

**B8.2.2 Example Simulation Results.** The simulation programs used to generate example results for the ground-coupled slab-on-grade tests of Section 5.2.4 are described in Annex B11, Section B11.2.2.

**B8.2.2.1 Purpose of Including Example Simulation Results with Analytical Verification Tests.** Because the analytical solution and verified numerical model results constitute a reliable set of theoretical results (mathematical and secondary mathematical truth standards, respectively), the primary purpose of including simulation results for the ground-coupled slab-on-grade cases is to allow simulationists to compare their relative agreement (or disagreement) versus the analytical solution and verified numerical model results to that for other simulation results. Perfect agreement among simulations and the analytical solution or verified numerical model results is not necessarily expected. The results give an indication of what sort of agreement is possible between simulation results and the analytical solution or verified numerical model results. Because the physical assumptions of a simulation may be different from those of the analytical solution or verified numerical model results, a tested program may disagree with such solutions without necessarily being incorrect. However, it is worthwhile to investigate the sources of the differences.

**B8.2.2.2 Zone Heating Load versus Floor Conduction Results.** Heat conducted through the floor slab should be equal to the zone-heating load because the test cases specify adiabatic above-grade walls and ceiling such that heating zone air to maintain the thermostat setpoint drives all heat losses through the floor. The verified numerical models were run independently of whole-building energy simulation models. For the “b”-series and “c”-series cases, the zone air temperature was input to verified numerical models as an inside boundary condition for an interior convective surface coefficient (thermal resistance between the zone air and floor slab surface). Therefore, verified numerical-model results are included with the floor conduction results only. However, for whole-building simulation programs that do not disaggregate floor conduction in their output, the zone heating load results are directly comparable to the floor conduction results. Minor differences in zone heating load versus floor conduction may occur if a simulation program cannot model strictly adiabatic above-grade walls

and ceilings, but rather is applying the lowest thermal conductance the simulation allows.

**B8.2.3 Nomenclature for RESULTS5-2B.xlsx.** Results are shown using case designators; e.g., “GC30b” is Case GC30b (see Section 5.2.4.1.1). Sensitivity results are listed using two case numbers separated by a minus sign; e.g., “GC60b – GC30b” is the difference between Case GC60b (see Section 5.2.4.1.6) and Case GC30b (see Section 5.2.4.1.1).

<u>ABS</u>	≡	<u>absolute value</u>
<u>adiab.</u>	≡	<u>adiabatic</u>
<u>AR</u>	≡	<u>aspect ratio</u>
<u>BASECALC</u>	≡	<u>simulation model: BASECALC V1.0e (see Table B11-4)</u>
<u>BESTEST</u>	≡	<u>Building Energy Simulation Test and Diagnostic Method</u>
<u>CSIRO</u>	≡	<u>Commonwealth Scientific and Industrial Research Organisation, Australia (see Table B11-4)</u>
<u>Delta</u>	≡	<u>results difference</u>
<u>Dif</u>	≡	<u>difference</u>
<u>DIT</u>	≡	<u>modeler: Dublin Institute of Technology, Ireland (see Table B11-4)</u>
<u>DT</u>	≡	<u>differential temperature</u>
<u>E</u>	≡	<u>deep-ground depth (Section 5.2.4 only)</u>
<u>EnergyPlus</u>	≡	<u>simulation model: EnergyPlus 2.0.0.025 (see Table B11-4)</u>
<u>ESP-r/BASESIMP</u>	≡	<u>simulation model: ESP-r/BASESIMP (see Table B11-4)</u>
<u>F</u>	≡	<u>far field dimension, m</u>
<u>FLUENT</u>	≡	<u>verified numerical model: by PAAET using Fluent 6.0.20 (see Table B11-4)</u>
<u>GARD</u>	≡	<u>modeler: GARD Analytics, United States (see Table B11-4)</u>
<u>GHT</u>	≡	<u>simulation model: GHT (see Table B11-4)</u>
<u>h</u>	≡	<u>convective surface coefficient, W/m<sup>2</sup>·K</u>
<u>h.int</u>	≡	<u>interior convective surface coefficient, W/m<sup>2</sup>·K</u>
<u>h.ext</u>	≡	<u>exterior convective surface coefficient, W/m<sup>2</sup>·K</u>
<u>Htg</u>	≡	<u>heating</u>
<u>inf.</u>	≡	<u>infinity</u>
<u>ISO</u>	≡	<u>International Organization for Standardization</u>
<u>k</u>	≡	<u>thermal conductivity, W/m<sup>2</sup>·K</u>
<u>kWh</u>	≡	<u>kilowatt-hour</u>
<u>Large slab/10</u>	≡	<u>large slab results divided by 10</u>

<u>LinDt</u>	≡	<u>linearly varying perimeter boundary surface temperature (see Case GC10a, Section 5.2.4.2.1)</u>
<u>low h</u>	≡	<u>low interior and exterior surface coefficients</u>
<u>MATLAB</u>	≡	<u>verified numerical model: by DIT using MATLAB 7.0.4.365 (R14) (see Table B11-4)</u>
<u>Max</u>	≡	<u>maximum of example results</u>
<u>Mean</u>	≡	<u>mean of example results</u>
<u>Min</u>	≡	<u>minimum of example results</u>
<u>NRCan</u>	≡	<u>Natural Resources Canada</u>
<u>NREL</u>	≡	<u>modeler: National Renewable Energy Laboratory (see Table B11-4)</u>
<u>ODB</u>	≡	<u>outdoor dry-bulb temperature, °C</u>
<u>PAAET</u>	≡	<u>modeler: Public Authority of Applied Education and Training, Kuwait (see Table B11-4)</u>
<u>sp</u>	≡	<u>steady periodic—test case using harmonically varying outdoor dry-bulb temperature</u>
<u>ss</u>	≡	<u>steady state—test case using constant outdoor dry-bulb temperature</u>
<u>SUNREL-GC</u>	≡	<u>simulation model: SUNREL-GC 1.14.01 (see Table B11-4)</u>
<u>TESS</u>	≡	<u>modeler: Thermal Energy System Specialists, United States (see Table B11-4)</u>
<u>Tot</u>	≡	<u>total</u>
<u>TRNSYS</u>	≡	<u>verified numerical model: TRNSYS 16.1 (see Table B11-4)</u>
<u>v</u>	≡	<u>versus</u>
<u>VA114/ISO-13370</u>	≡	<u>simulation model: VA114 using ISO-13370 ground heat transfer calculation (see Table B11-4)</u>
<u>VABI</u>	≡	<u>modeler: VABI Software, Netherlands (see Table B11-4)</u>
<u>W</u>	≡	<u>watts</u>
<u>Wh/h</u>	≡	<u>watt-hour per hour</u>
<u>X</u>	≡	<u>variable dimension along x-axis, cm (see Figure 6-1)</u>
<u>Y</u>	≡	<u>variable dimension along y-axis, cm (see Figure 6-1)</u>

**B8.2.4 Example Results.** Tables B8-3 and B8-4 list example results tables and figures included in the RESULTS5-2B.PDF and RESULTS5-2B.XLSX files. The RESULTS5-2B.PDF file represents these tables and figures sequentially. The sheet and cell range columns are only applicable to the RESULTS5-2B.XLSX file. Verified numerical-model results are shown in the bar charts with blue shaded background bars, and the analytical solution result (Case GC10a) is shown with a magenta background bar.



**TABLE B8-3 B8.2.4 Example Results Tables**

<b>Table</b>	<b>Description</b>	<b>Sheet Tab</b>	<b>Cell Range</b>
Table B8.2-1	<u>"a"-Series Case Summary, Numerical Model Verification</u>	Tables 1	B7-L24
Table B8.2-2	<u>Steady-State Conduction</u>	Tables 2	B7-Q26
Table B8.2-3	<u>Steady-State Supporting Information</u>	Tables 2	B29-Q42
Table B8.2-4	<u>Steady-Periodic Last-Simulation-Year Conduction</u>	Tables 2	B46-Q83
Table B8.2-5	<u>Steady-Periodic Last-Simulation-Year Peak-Hour Conduction</u>	Tables 3	B7-AA62
Table B8.2-6	<u>Time from Coldest Hour (Jan 15, Hour 4) to Peak Conduction Occurrence</u>	Tables 4	B7-Q33
Table B8.2-7	<u>Steady-Periodic Supporting Information</u>	Tables 4	B35-Q60
Table B8.2-8	<u>Steady-Periodic Minimum ODB and Time of Occurrence</u>	Tables 5	B8-AE38
Table B8.2-9	<u>Delta Steady-State Conduction</u>	Tables 6	B7-Q30
Table B8.2-10	<u>Delta Steady-Periodic Annual Total Conduction</u>	Tables 6	B32-Q56
Table B8.2-11	<u>Delta Steady-Periodic Last-Year Peak Hour Floor Conduction</u>	Tables 6	B58-Q82
Table B8.2-12	<u>Delta Steady-Periodic Conduction v Coldest Hour Phase Shift</u>	Tables 6	B84-Q108

**TABLE B8-4 B8.2.4 Example Results Figures**

<b>Figure</b>	<b>Title</b>	<b>Sheet Tab</b>
B8.2-1	<u>IEA BESTEST Ground Coupling: In-Depth Floor Slab Steady-State Floor Conduction</u>	Figure B8.2-1 QFSS
B8.2-2	<u>IEA BESTEST Ground Coupling: In-Depth Floor Slab Steady-State Floor Conduction Sensitivity</u>	Figure B8.2-2 dQFSS
B8.2-3	<u>IEA BESTEST Ground Coupling: In-Depth Floor Slab Steady-State Zone Heating Load</u>	Figure B8.2-3 QZSS
B8.2-4	<u>IEA BESTEST Ground Coupling: In-Depth Floor Slab Steady-State Zone Heating Load Sensitivity</u>	Figure B8.2-4 dQZSS
B8.2-5	<u>IEA BESTEST Ground Coupling: In-Depth Floor Slab Steady-State (Zone Heating Load)—(Floor Conduction)</u>	Figure B8.2-5 QZ-FSS
B8.2-6	<u>IEA BESTEST Ground Coupling: In-Depth Floor Slab Case GC10a Modeling Parameters</u>	Figure B8.2-6 GC10Par
B8.2-7	<u>IEA BESTEST Ground Coupling: In-Depth Floor Slab Steady-State Zone Temperature</u>	Figure B8.2-7 TZSS
B8.2-8	<u>IEA BESTEST Ground Coupling: In-Depth Floor Slab, GC10a Steady-State Surface Temperatures (Y = 0, thru edge center)</u>	Figure B8.2-8 TempGC10a-Surf
B8.2-9	<u>IEA BESTEST Ground Coupling: In-Depth Floor Slab, GC10a Steady-State Surface Temperatures (Y = X, thru corner)</u>	Figure B8.2-9 TempGC10a-Surf-diag
B8.2-10	<u>IEA BESTEST Ground Coupling: In-Depth Floor Slab, GC10a, GC30a Steady-State Near-Surface Temperatures (Y = 0, thru center of edge)</u>	Figure B8.2-10 TempGC10a-30a
B8.2-11	<u>IEA BESTEST Ground Coupling: In-Depth Floor Slab, GC10a, GC30a Steady-State Near-Surface Temperatures (Y = X, thru corner)</u>	Figure B8.2-11 TempGC10a-30a-diag
B8.2-12	<u>IEA BESTEST: In-Depth Floor Slab, GC30b, GC60b, GC65b Steady-State Near-Surface Temperatures (Y = 0, thru center of edge)</u>	Figure B8.2-12 TempGC30b-65b
B8.2-13	<u>IEA BESTEST: In-Depth Floor Slab, GC30b, GC60b, GC65b Steady-State Near-Surface Temperatures (Y = X, thru corner)</u>	Figure B8.2-13 TempGC30b-65b-diag
B8.2-14	<u>IEA BESTEST Ground Coupling: In-Depth Floor Slab Steady-Periodic Annual Floor Conduction</u>	Figure B8.2-14 QFSP
B8.2-15	<u>IEA BESTEST Ground Coupling: In-Depth Floor Slab Steady-Periodic Annual Floor Conduction Sensitivity</u>	Figure B8.2-15 dQFSP
B8.2-16	<u>IEA BESTEST Ground Coupling: In-Depth Floor Slab Steady-Periodic Annual Zone Heating Load</u>	Figure B8.2-16 QZSP
B8.2-17	<u>IEA BESTEST Ground Coupling: In-Depth Floor Slab Steady-Periodic Annual Zone Heating Load Sensitivity</u>	Figure B8.2-17 dQZSP

**TABLE B8-4 B8.2.4 Example Results Figures (Continued)**

<b>Figure</b>	<b>Title</b>	<b>Sheet Tab</b>
<u>B8.2-18</u>	<u>IEA BESTEST Ground Coupling: In-Depth Floor Slab Steady-Periodic (Zone Heating Load) – (Floor Conduction)</u>	<u>Figure B8.2-18 QZ-FSP</u>
<u>B8.2-19</u>	<u>IEA BESTEST Ground Coupling: In-Depth Floor Slab Hourly Floor Conduction, GC40a</u>	<u>Figure B8.2-19 GC40aHourly-1</u>
<u>B8.2-20</u>	<u>IEA BESTEST Ground Coupling: In-Depth Floor Slab Hourly Floor Conduction, GC40b</u>	<u>Figure B8.2-20 GC40bHourly-2</u>
<u>B8.2-21</u>	<u>IEA BESTEST Ground Coupling: In-Depth Floor Slab Hourly Floor Conduction, GC40c</u>	<u>Figure B8.2-21 GC40cHourly-1</u>
<u>B8.2-22</u>	<u>IEA BESTEST Ground Coupling: In-Depth Floor Slab Steady-Periodic Phase Shift, Time from Coldest ODB to Peak Floor Conduction</u>	<u>Figure B8.2-22 PhF</u>
<u>B8.2-23</u>	<u>IEA BESTEST Ground Coupling: In-Depth Floor Slab Steady-Periodic Phase Shift Sensitivity, Floor Conduction v. ODB</u>	<u>Figure B8.2-23 dPhF</u>
<u>B8.2-24</u>	<u>IEA BESTEST Ground Coupling: In-Depth Floor Slab Steady-Periodic Phase Shift, Time from Coldest ODB to Peak Zone Load</u>	<u>Figure B8.2-24 PhZ</u>
<u>B8.2-25</u>	<u>IEA BESTEST Ground Coupling: In-Depth Floor Slab Delta Steady-Periodic Phase Shift Sensitivity, Zone Load v. ODB</u>	<u>Figure B8.2-25 dPhZ</u>
<u>B8.2-26</u>	<u>IEA BESTEST Ground Coupling: In-Depth Floor Slab Steady-Periodic Annual Peak-Hour Floor Conduction</u>	<u>Figure B8.2-26 PFSP</u>
<u>B8.2-27</u>	<u>IEA BESTEST Ground Coupling: In-Depth Floor Slab Steady-Periodic Annual Peak-Hour Floor Conduction Sensitivity</u>	<u>Figure B8.2-27 dPFSP</u>
<u>B8.2-28</u>	<u>IEA BESTEST Ground Coupling: In-Depth Floor Slab Steady-Periodic Annual Peak-Hour Zone Heating Load</u>	<u>Figure B8.2-28 PZSP</u>
<u>B8.2-29</u>	<u>IEA BESTEST Ground Coupling: In-Depth Floor Slab Steady-Periodic Annual Peak-Hour Zone Heating Load Sensitivity</u>	<u>Figure B8.2-29 dPZSP</u>
<u>B8.2-30</u>	<u>IEA BESTEST Ground Coupling: In-Depth Floor Slab Steady-Periodic (Peak Zone Heating Load) – (Peak Floor Conduction)</u>	<u>Figure B8.2-30 PZ-FSP</u>
<u>B8.2-31</u>	<u>IEA BESTEST Ground Coupling: In-Depth Floor Slab Steady-Periodic Zone Temperature</u>	<u>Figure B8.2-31 TZSP</u>
<u>B8.2-32</u>	<u>IEA BESTEST Ground Coupling: In-Depth Floor Slab Steady-Periodic Minimum ODB</u>	<u>Figure B8.2-32 ODBmin</u>

*Revise Annex B9 as shown. New Figures B9-5, B9-6, and B9-7 are included at the end of the text of this annex; current figures B9-5, B9-6, and B9-7 are renumbered to B9-8, B9-9, and B9-10 respectively.*

**INFORMATIVE ANNEX B9  
DIAGNOSING THE RESULTS USING THE  
FLOW DIAGRAMS**

**B9.1 General Description.** Figures B9-1 through B9-10~~7~~ contain a set of flow diagrams that serve as a guide for diagnosing the cause of disagreeing results that may arise from using this method of test. These flow diagrams list the feature(s) being tested, thus indicating potential sources of algorithmic differences.

**B9.2 Comparing Tested Software Results to Other Example Results**

**B9.2.1** “Example results” are either results presented in informative Annexes B8 and B16 or other results that were generated using this standard method of test.

**B9.2.2** In this annex we provide no formal criteria for when results agree or disagree. Determination of when results agree or disagree is left to the user. In making this determination, the user should consider

- a. magnitude of results for individual cases,
- b. magnitude of difference in results between certain cases (e.g., “Case 610-Case 600”),
- c. same direction of sensitivity (positive or negative) for difference in results between certain cases (e.g., Case 610–Case 600),
- d. if results are logically counterintuitive with respect to known or expected physical behavior,
- e. availability of analytical or quasi-analytical solution results (i.e., mathematical truth standard as described in informative Annex B16, Section B16.2), or verified numerical-model results (see Annex B8, Section B8.2.1),
- f. for analytical verification test cases, the degree of disagreement that occurred for other simulation results ~~in Annex B16~~ versus the ~~quasi-analytical or analytical solu-~~

tion, quasi-analytical solution, or verified numerical model results,

- g. example simulation results do not represent a truth standard.

[...]

## **B9.4 Diagnostic Logic Flow Diagrams for Building Thermal Envelope and Fabric Load and Ground-Coupled Slab-on-Grade Tests (Section 5.2)**

*Insert new Section B9.4.4.*

### **B9.4.4 Ground-Coupled Slab-On-Grade Analytical Verification Tests**

**B9.4.4.1** Figures B9-5, B9-6, and B9-7 contain a set of flow diagrams that serve as a guide for diagnosing the cause of disagreeing results that may arise from using the ground coupling test cases of Section 5.2.4. The flow diagrams represent three separate paths: the “a”-series cases (Figure B9-5), the “b”-series cases (Figure B9-6), and the “c”-series cases (Figure B9-7). Selecting “a”-series versus “b”-series or “c”-series depends on the capabilities of the program being tested. For detailed numerical models, the “a”-series cases are to be run first and then the “b” series cases. For most other models, the “b”-series cases should be run first. The “c”-series cases are for models that can match the constraints of NRCan’s BASESIMP model.

**B9.4.4.2 Testing Models Integrated within Whole-Building Simulation Programs.** For slab-on-grade models integrated with whole-building energy simulation programs, the flow diagrams may be used in two ways. The most powerful but time-consuming way is to perform all “b”-series and “c”-series cases (and the “a”-series cases if the model being tested is a detailed numerical model), and then use the diagnostic logic in the flow diagrams to analyze the results. The least time-consuming way is to perform the tests in sequence according to the flow diagrams, beginning with Figure B9-5 for detailed numerical models and Figure B9-6 for other less detailed models. The flow diagram of Figure B9-6 begins with a basic performance test (Case GC30b). It is very important to have confidence in your Case GC30b results before proceeding to the other cases. If output from the tested program agrees satisfactorily with the verified numerical-model results for Case GC30b, continue to check output for the remaining cases according to the flow diagram. If output from the tested program disagrees with verified numerical-model results for Case GC30b, check for input errors. If no input error is found, run all other test cases and follow the diagnostic logic accordingly, as this may help to isolate the source of the difference to one of the specifically tested parameters.

**B9.4.4.3 Testing Detailed Numerical Models.** When testing detailed numerical models with the “a”-series cases, experience from field trials of the test procedure indicates to initially begin by checking the results of each case individually before moving on to additional cases. Specifically, first run only Case GC10a and check the results versus the analytical solution. If the result is satisfactory, move on to only

Case GC30a, and similarly for GC40a, then GC30b, then GC40b, as each addresses a fundamental change in boundary conditions for steady-state and dynamic modeling. After each case is checked, it is reasonable to proceed with batch-running the remaining cases: it is recommended to run GC60b, GC65b, and GC30c as one batch followed by the remaining “b”- and “c”-series dynamic cases. Because of geometry variations for GC45b, GC45c, and GC50c, it may be preferable to run those cases last.

**B9.4.4.4 Consideration of Verified Numerical-Model Results.** At a minimum, the user should compare output with the verified numerical-model results provided in Annex B8, Section B8.2. The user may also choose to compare output with the example simulation results in that section, or with other results that were generated using Section 5.2.4 of this test procedure. Information about how the verified numerical-model results and example simulation results were produced is included in Annex B11, Section B11.2. For convenience to users who wish to plot or tabulate their results along with the analytical solution or example simulation results, or both, an electronic version of the example results has been included with the file RESULTS5-2B.XLSX with the accompanying electronic files. Regarding determination of agreement of results discussed in Section B9.2.2, in making this determination for the ground coupling tests of Section 5.2.4, the user should consider that the range of disagreement among the verified numerical-model results represents a secondary mathematical truth standard based on acceptance of the underlying physical assumptions represented by the case specifications. Note that the underlying physical assumptions of the case definitions are a simplification of reality and may not fully represent empirical behavior.

*Revise section B9.5 as shown. Insert new figures B9-5, B9-6, and B9-7. Rename current figures B9-5, B9-6, and B9-7 to B9-8, B9-9, and B9-10 respectively, as shown after the new figures.*

**B9.5 Diagnostic Logic Flow Diagram for Space Cooling Equipment Performance Tests (Section 5.3).** Flow diagrams are included here for cases CE100–CE200 (Figure B9-8§) and cases CE300–CE545 (Figures B9-96 and B9-107).

#### **B9.5.1 Analytical Verification Tests, Cases CE100-CE200**

**B9.5.1.1 Introduction.** Cases CE100–CE200 (see Sections 5.3.1 and 5.3.2) are to be run first. These are steady-state cases that test basic performance map modeling capabilities and utilize comparisons with quasi-analytical solutions that constitute a mathematical truth standard. The diagnostic logic flow diagram for these cases (Figure B9-8§) indicates similar diagnostics for dry-coil and wet-coil (without and with dehumidification) cases. This is really one continuous diagnostic path to be implemented for both dry-coil and wet-coil cases. Performing and analyzing results of the CE100 series tests in blocks, such as CE100–CE140 and CE150–CE200, or CE100–CE200, all at once is recommended. For the CE100 series cases, if a disagreement is uncovered for one of the cases, then fix it and rerun all the CE100 series cases. It is very important to have confidence in the results for cases CE100–CE200 before proceeding to the other cases.

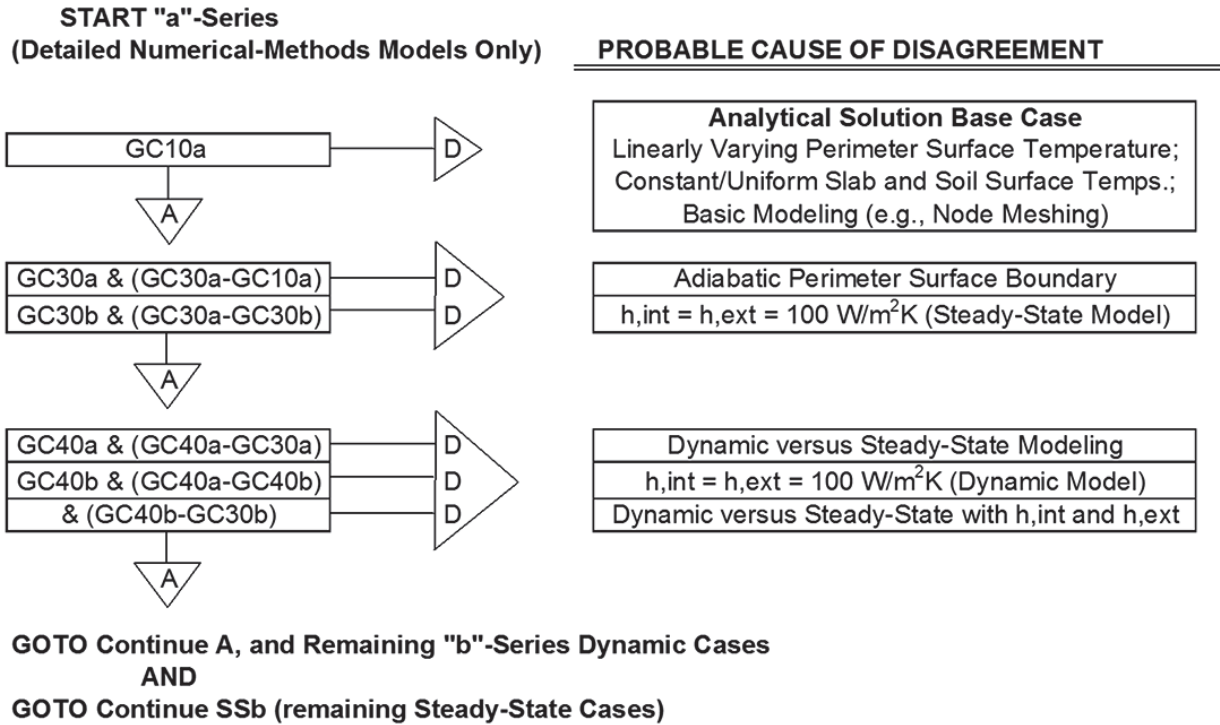

**ABBREVIATIONS**

A = Agree; D = Disagree. For these test cases, agreement/disagreement is determined relative to quasi-analytical solution results, including listed sensitivity cases.

**FIGURE B9-5 Cases GC10a-GC40b ("a"-series) diagnostic logic flow diagram.**

**B9.5.1.2 Consideration of Quasi-Analytical Solution Results.** As a minimum, the user should compare output with the quasi-analytical solution results found in Annex B16, Section B16.5.1. The user may also choose to compare output with the example simulation results in that section or with other results that were generated using Sections 5.3.1 and 5.3.2 of this test procedure. Information about how the quasi-analytical solutions and example simulation results were produced is included in Annex B17. For convenience to users who wish to plot or tabulate their results along with the quasi-analytical solution or example simulation results, or both, an electronic version of the example results has been included with the file RESULTS5-3A.XLS on the accompanying electronic media provided with this standard CD. Regarding determination of agreement of results discussed in B9.2.2, in making this determination for the space cooling equipment performance analytical verification tests of Sections 5.3.1 and 5.3.2, the user should consider that the quasi-analytical solution results given in Annex B16, Section B16.5.1 represent a mathematical truth standard (i.e., a mathematically provable and deterministic set of results based on acceptance of the underlying physical assumptions represented by the case specifications, discussed further in Annex B16, Section B16.2). Note that although the underlying physical assumptions of the case definitions of the mechanical equipment are consistent with those of typical manufacturer equipment performance data, they are by definition a simplification of reality and may not fully represent real empirical behavior.

**B9.5.2 Comparative Tests, Cases CE300-CE545.** After successfully completing cases CE100-CE200, go on to cases CE300-CE545 (see Sections 5.3.3 and 5.3.4). These cases test additional model features under more dynamic (hourly varying) conditions. Example simulation results for cases CE300-CE545 (see Annex B16, Section B16.5.2) do not include analytical solutions, so analytical verification versus a mathematical truth standard is not possible for those cases. The flow diagrams for cases CE300-CE545 may be used in two ways. The most powerful but time-consuming way is to perform all cases CE300-CE545 and then use the diagnostic logic in the flow diagrams to analyze the results. The least time-consuming way is to perform the tests in sequence according to the flow diagrams, beginning with Figure B9-96.

The flow diagram of Figure B9-96 begins with a basic performance test (Case CE300). It is very important to have confidence in your Case CE300 results before proceeding to the other cases. If output from the tested program agrees satisfactorily with other example results for Case CE300, then continue to check output for the remaining cases according to the flow diagram. If output from the tested program disagrees with other example results for Case CE300, then follow the diagnostic logic accordingly. The diagnostic logic for cases CE500-CE545 is presented in Figure B9-107. Cases CE500-CE545 test similar effects as cases CE100-CE200, but in an hourly dynamic context using expanded performance data without analytical verification. The sensitivity result "CE500-CE300" isolates the

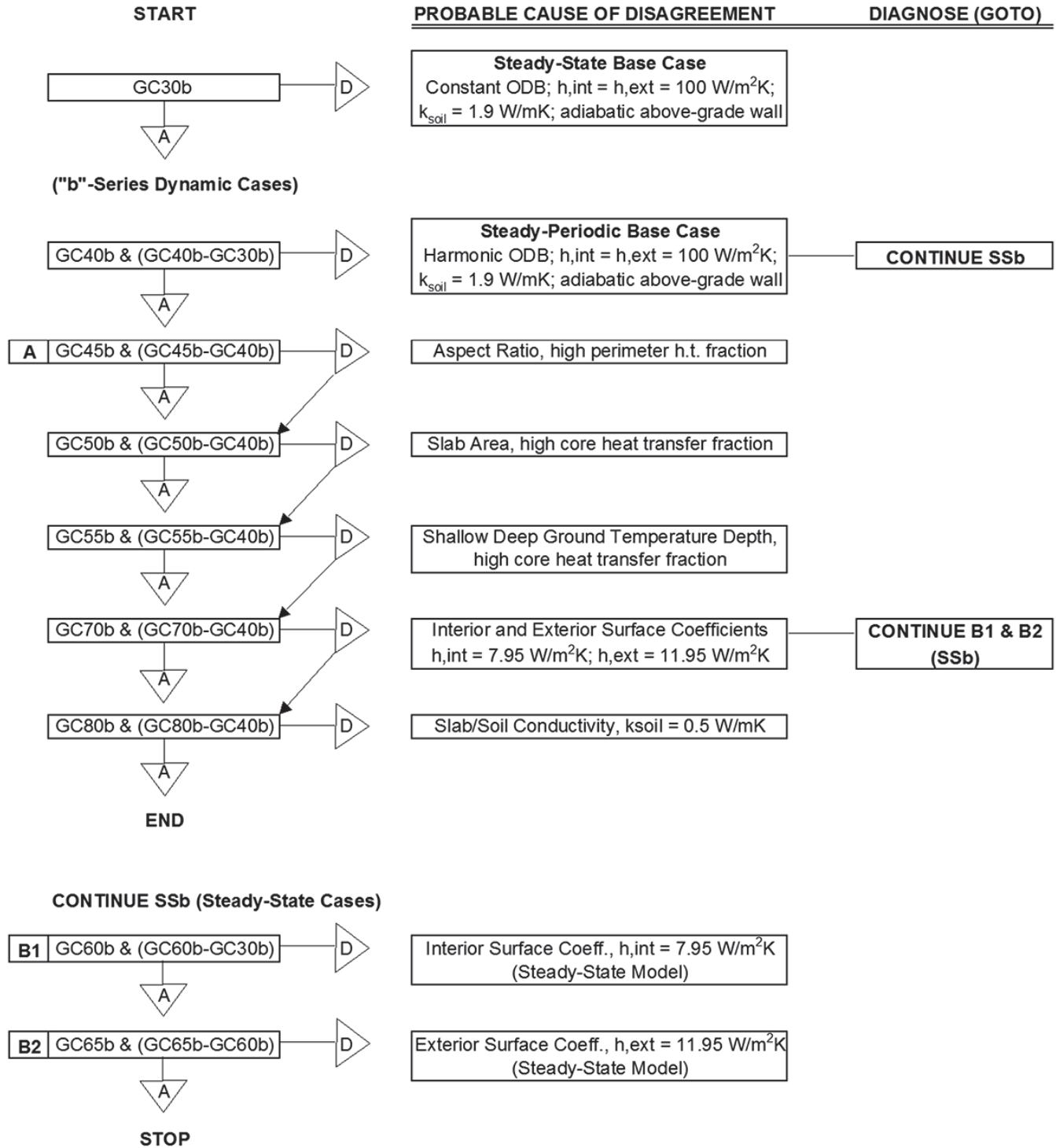

**ABBREVIATIONS**

A = Agree; D = Disagree. For these test cases, agreement/disagreement is determined relative to quasi-analytical solution results, including listed sensitivity cases.

**FIGURE B9-6 Cases GC30b-GC80b ("b"-series) diagnostic logic flow diagram.**

**START ("c"-Series Diagnostic Logic)**

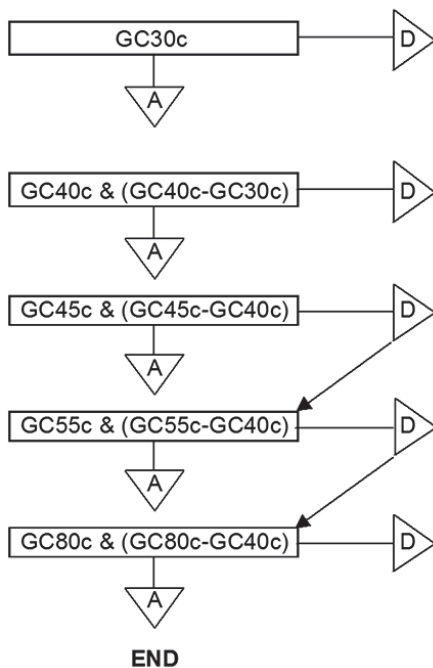

**PROBABLE CAUSE OF DISAGREEMENT**

**"c"-Series Steady-State Base Case**  
 Constant ODB;  $h_{int} = h_{ext} = 100 \text{ W/m}^2\text{K}$ ;  
 $k_{soil} = 1.9 \text{ W/mK}$ ; adiabatic above-grade wall

**"c"-Series Steady-Periodic Base Case**  
 Harmonic ODB;  $h_{int} = h_{ext} = 100 \text{ W/m}^2\text{K}$ ;  
 $k_{soil} = 1.9 \text{ W/mK}$ ; adiabatic above-grade wall

Aspect Ratio, high perimeter h.t. fraction

Shallow Deep Ground Temperature Depth,  
 high core heat transfer fraction

Slab/Soil Conductivity,  $k_{soil} = 0.85 \text{ W/mK}$

**ABBREVIATIONS**

A = Agree; D = Disagree. For these test cases, agreement/disagreement is determined relative to quasi-analytical solution results, including listed sensitivity cases.

**FIGURE B9-7 Cases GC30c-GC80c ("c"-series cases) diagnostic logic flow diagram.**

effect of outside air, but with some noise because of varying internal gains schedules between Case CE300 and Case CE500, and because the air distribution fan cycles with the compressor in Case CE500. In contrast with steady-state cases CE100–CE200 that were solved analytically, the more realistic nature of cases CE300–CE545 allows us to gauge the importance of being able to simulate various effects accurately in terms of annual energy performance. For example, a large percentage difference for a given result that has only a very small impact on annual energy use may not be of concern, whereas a small percentage difference with a large impact on annual energy use may be deemed important.

*Change B9.6.1 header as shown.*

**B9.6.1 Example Using Flow Diagrams for Building Thermal Envelope and Fabric Load Tests (Sections 5.2.1 and 5.2.2)**

*Insert Section B9.6.2 and renumber subsequent sections as shown.*

**B9.6.2 Example Using Flow Diagrams for Ground-Coupled Slab-on-Grade Analytical Verification Tests (Section 5.2.4).** A program shows disagreement with GC70b. Figure B9-6 suggests the potential source of algo-

rithmic differences includes modeling of interior and exterior surface heat transfer coefficients. The user is directed to check diagnostics B1 and B2. If the disagreement persists for B1, the cause is likely related to modeling of the slab interior surface heat transfer coefficient. If there is no disagreement for B1, go on to B2. If the disagreement appears for B2, its cause is likely related to modeling the exterior surface heat transfer coefficient. If there is no disagreement for B1 or B2, the difference could be related to dynamic modeling versus steady-state modeling or some other problem.

**B9.6.32 Example Using Flow Diagrams for Space Cooling Equipment Performance Analytical Verification Tests (Sections 5.3.1 and 5.3.2).** A program shows agreement with Case CE100, but shows large disagreement with the quasi-analytical solution results of energy consumption predictions for Case CE130. Figure B9-85 suggests the potential algorithmic source of the difference is with the algorithm for incorporating part-load operating effects into the energy consumption for a dry coil.

**B9.6.43 Example Using Flow Diagrams for HVAC Equipment Performance Comparative Tests (Sections 5.3.3 and 5.3.4).** A program shows disagreement with CE300. Because this is the base case for the CE300 series, Figure B9-96 suggests a number of potential sources of

**TABLE B10-1 Index of Sheets in RESULTS5-2A.XLS**

Sheet	Description
Read Me	General directions to using this workbook.
Adding Results	Instructions for adding new results. Also has cell map to individual data items in example results and “YourData” sheets.
YourData	For inputting new simulation test results; see sheet “Adding Results” for instructions. Data input to this sheet will pass through into all tables and charts.
Title Page	Title Page for printed informative example or new comparison results. Sets headers for tables and charts. See instructions on page.
Program List	List of simulation programs and organization producing Annex B8, Section B8.1 example results.
Table List	Listing of Informative Annex B8, Section B8.1 tables with locations.
Figure List	Listing of Informative Annex B8, Section B8.1 figures with locations.
Tables 1 through Tables 6 (6 sheets)	Formatted summary results tables, including example simulation results and statistics. See Annex B8, Section B8.1.2.3 or the “Table List” sheet in RESULTS5-2A.XLS for a list of all tables with sheet tab and cell range location. New results (entered in sheet “YourData”) automatically appears on the right side of each table.
Fig B8-1 Ann Incident Solar through Fig B8-59 Hrly-Loads-Case900 (59 sheets)	59 summary charts (one per sheet). See Annex B8, Section B8.1.2.3 or the “Figure List” sheet in RESULTS5-2A.XLS for a list of all figures with sheet tab location.
Data for charts	Unformatted data for use by the 59 charts. New results (entered in sheet “YourData”) automatically appear on the right side of each data table.
ESP-DMU through TASE (8 sheets)	Results sheets from each simulation program used to produce example results.

algorithmic differences, including dynamic variation of load, 15% outside air (mixed with return air), continuous indoor fan operation, or hourly dynamic equipment performance as  $f(\text{EDB, EWB, ODB, PLR})$ . The user is directed to check diagnostics C1 and C2 utilizing Case CE500 (see Figure B9-107). If the disagreement persists for C1 and/or C2, this likely eliminates outside air mixing and continuous fan operation as the cause of the problem. The user is then directed to run the remainder of the CE500-series cases, and if the disagreement persists to also recheck results from cases CE100–CE200 (see Figure B9-85). If the cause of the disagreement persists for the remaining CE500-series cases and the CE100 results are still satisfactory, then the problem is likely isolated to performance-map parameter  $f(\text{ODB, EWB, EDB})$  sensitivity over the expanded range of performance data or some other problem related to hourly dynamic modeling.

*Revise figure titles as shown.*

**Figure B9-85 Cases CE100–CE200 (steady-state analytical verification) diagnostic logic flow diagram.**

**Figure B9-96 Cases CE300–CE440 (comparative test cases with outside air) diagnostic logic flow diagram.**

**Figure B9-107 Cases CE500–CE545 (comparative test cases without outside air) diagnostic logic flow diagram.**

*Revise Section B10.1 as shown.*

## INFORMATIVE ANNEX B10 INSTRUCTIONS FOR WORKING WITH RESULTS SPREADSHEETS PROVIDED WITH THE STANDARD

**B10.1 Documentation for RESULTS5-2A.XLS (given in RESULTS5-2A.DOC).** This spreadsheet contains the IEA 12B/21C participant results that are presented as informative example results for the Section 5.2.1, 5.2.2, and 5.2.3 Building Thermal Envelope and Fabric Load Tests as described in Annex B8, Section B8.1. Table B10-1 presents an index of all sheets contained in the RESULTS5-2A.XLS file.

The “ReadMe” sheet provides a general overview of the file. Example results tables and figures are listed with location (sheet tab and cell range) in Annex B8, Section B8.1.2.3 and also on the “Table List” and “Figure List” sheets in the XLS file.

New results can be imported to the “YourData” sheet and will automatically appear in all tables and also in the graphic figures. The “YourData” sheet has been designed with the same data structure (data units, format, and position) as the Standard Output Report spreadsheet Sec5-2Aout.XLS file so that new results can be copied directly. Import data so that Cell B61 of Sec5-2A out.XLS is in B61 of Sheet “YourData”. Check that the first value (Annual Heating Load for Case

600) is in YourData!B65. The “Adding Results” sheet has

**TABLE B10-2 Index of Sheets in RESULTS5-2B.XLSX**

<u>Sheet</u>	<u>Description</u>
<u>Read Me</u>	<u>General directions to using this workbook.</u>
<u>Adding Results</u>	<u>Instructions for adding new results. Also has cell map to individual data items in example results and “YourData” sheets.</u>
<u>YourData</u>	<u>For inputting new simulation test results, see sheet “Adding Results” for instructions. Data input to this sheet will pass through into all tables and charts.</u>
<u>Title Page</u>	<u>Title Page for printed informative example or new comparison results. Sets headers for tables and charts. See instructions on page.</u>
<u>Program List</u>	<u>List of simulation programs and organization producing AnnexB8, Section B8.2 example results.</u>
<u>Table List</u>	<u>Listing of Informative Annex B8, Section B8.2 tables with locations.</u>
<u>Figure List</u>	<u>Listing of Informative Annex B8, Section B8.2 figures with locations.</u>
<u>Tables 1 through Tables 6 (6 sheets)</u>	<u>Formatted summary results tables, including example simulation results and statistics. See Annex B8, Section B8.2.4 or the “Table List” sheet in RESULTS5-2B.XLSX for a list of all tables with sheet tab and cell range location. New results (entered in sheet “YourData”) automatically appear on the right side of each table.</u>
<u>Fig-B8.2-1 QFSS through Fig-B8.2-32 ODBmin (32 sheets)</u>	<u>32 summary charts (one per sheet). See Annex B8, Section B8.2.4 or the “Figure List” sheet in RESULTS5-2B.XLSX for a list of all figures with sheet tab location.</u>
<u>Aggregator</u>	<u>Unformatted data compilation, all programs. New results (entered in sheet “YourData”) automatically appear on the right side of each data table.</u>
<u>ABSdata through DELdata</u>	<u>These sheets are similar to ‘Aggregator.’ Formatted for use as source data for charts and tables.</u>
<u>Analytical</u>	<u>Analytical solution for Case GC10a</u>
<u>Basecalc through VA114</u>	<u>Results from each simulation program.</u>

instructions for accomplishing this and also has a full tabulation of results locations. New results data will appear in the rightmost column of each table and in all figures.

***Renumber sections B10.2–B10.5 as shown.***

**B10.32 Documentation for RESULTS5-3A.XLS (given in RESULTS5-3A.DOC)**

**B10.43 Documentation for RESULTS5-3B.XLS (given in RESULTS5-3B.DOC)**

**B10.54 Documentation for RESULTS5-4.XLS (given in RESULTS5-4.DOC)**

**B10.65 Documentation for RESULTS7-2.XLS (also see given in RESULTS7-2.DOC)**

***Existing Tables B10-2 through B10-5 and all references to those tables will be renumbered to B10-3 through B10-6 respectively.***

***Insert new section B10.2 as shown.***

**B10.2 Documentation for RESULTS5-2B.XLSX (given in RESULTS5-2B.DOC).** This spreadsheet contains the IEA Task 34/43 participant results that are presented as

informative example results for the Section 5.2.4 Ground-Coupled Slab-On-Grade Analytical Verification Tests as described in Annex B8, Section B8.2. Table B10-2 presents an index of all sheets contained in the RESULTS5-2B.XLSX file.

The “ReadMe” sheet provides a general overview of the file. Example results tables and figures are listed with location (sheet tab and cell range) in Annex B8, Section B8.2.4 and also on the “Table List” and “Figure List” sheets in the XLS file.

New results can be imported to the “YourData” sheet and will automatically appear in all tables and also in the graphic figures. The “YourData” sheet has been designed with the same data structure (data units, format, and position) as the Standard Output Report spreadsheet Sec5-2Bout.XLS file so that new results can be copied directly. Import data so that Cell E53 of Sec5-2Bout.XLS is in E53 of Sheet “YourData.” Check that  $q_{floor}$  for Case GC10a is in YourData!E60. The “Adding Results” sheet has instructions for accomplishing this and also has a full tabulation of results locations. New results data will appear in the rightmost column of each table and in all figures.



To print example results or example results with new user generated results, go to the “Title Page” sheet and follow the instructions starting in cell B5.

*Change title and edit Annex B11 and section B11.1 as shown below.*

**INFORMATIVE ANNEX B11  
PRODUCTION OF EXAMPLE RESULTS FOR BUILDING THERMAL ENVELOPE AND FABRIC LOAD AND GROUND-COUPLED SLAB-ON-GRADE TESTS OF SECTION 5.2**

This section describes the criteria used to select programs to produce the example results, provides details of the program versions used, and provides details of the analytical solutions.

Example results were created as part of the original research projects that developed the test cases in Section 5.2. Each project used different programs and/or program versions. Simulation programs used to develop the results were the current versions at the time of the original research; programs may have been updated since the example results were produced. For some test cases, analytical solutions or verified numerical-model results have been developed and serve as mathematical truth standards and secondary mathematical truth standards, respectively.

**B11.1 Results for Building Thermal Envelope and Fabric Load Cases of Sections 5.2.1, 5.2.2, and 5.2.3.** The full discussion of example results is included in IEA BESTEST.<sup>3</sup> Portions of that discussion have been included here.

The programs used to generate the example results for Sections 5.2.1, 5.2.2, and 5.2.3 are described in Table B11-1. Under the “computer program” column, the first entry in each cell is the proper program name and version number. The entries in parentheses are the abbreviations for the programs generally used in Annex B8, Section B8.1, and occasionally elsewhere in the informational annexes.

The second column of Table B11-1 indicates the university or national research facility with expertise in building science that wrote the simulation software. The third column indicates the university or national research facility with expertise in building science that performed the simulations. The majority of participating organizations that performed simulations either ran software written by their organization or otherwise ran other building energy simulation software in addition to that written by their organization.

To minimize the potential for user error, when feasible, more than one modeler developed input files for each program. This was done for BLAST, SERIRES, and TRN-SYS. Where disagreement in the inputs or results was found, the modelers were requested to resolve the differences. Where only a single modeler was involved, it was strongly recommended that inputs be carefully checked by another modeler familiar with the program.

Where improvements to simulation programs or simulation inputs were made as a result of running the tests, such improvements must have mathematical and physical

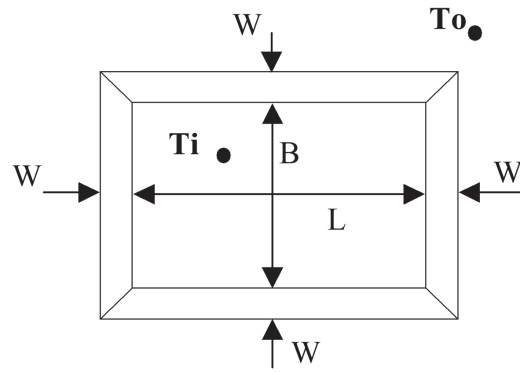

**FIGURE B11-1 Plan view of the floor geometry.**

bases and must be applied consistently across tests. Also, all improvements were required to be documented in modeler reports. Arbitrary modification of a simulation program’s input or internal code just for the purpose of more closely matching a given set of results was not allowed.

Input files used to generate the results are provided on the CD accompanying this standard; see the README\*.DOC file on the CD. The IEA participants that ran SERIRES 1.2 only provided two input files with their results. IEA participants that ran simulations for ESP, S3PAS, and TASE did not supply input files with their results.

*Renumber subsequent sections as shown below; no change to content there.*

**B11.1.1 Selection of Programs for Producing Example Results.**

**B11.1.2 Exclusion of Specific Results.**

**B11.1.3 Hourly Time Convention.**

*Insert new section B11.2.*

**B11.2 Example Results for Ground-Coupled Slab-On-Grade Analytical Verification Tests of Section 5.2.4.** An analytical solution was developed for Case GC10a (see Section B11.2.1). Verified numerical-model results were developed for all “a”-series test cases, and verified numerical-model and example simulation results were developed for all “b”-series and “c”-series test cases; see Section B11.2.2. Further details are described in the originating NREL/IEA research report.<sup>A-7</sup>

**B11.2.1 Analytical Solution for Steady-State Heat Flow through the Floor Slab (Case GC10a).** For the conditions of Figure B11-1 (same as Figure 5-12), given the slab of area  $L \times B$  surrounded by a perimeter surface boundary of thickness  $W$ , assume the surface temperature of the floor is  $T_i$ , and the temperature falls linearly across the perimeter boundary from  $T_i$  to the exterior ground surface temperature  $T_o$ , the exact solution for the problem under steady state 3D conditions has been determined.<sup>A-4</sup> The total heat flow through the slab into the ground is:

$$q = k(T_i - T_o) \frac{1}{\pi} F(L, B, W) \quad (\text{B11-1})$$

where

$T_i$  ≡ surface temperature of the floor, °C

$T_o$  ≡ temperature of the outside ground, °C

$k$  ≡ conductivity of floor slab and soil, W/(m·K)

And  $(L, B, W)$  is a function of  $L, B,$  and  $W$  with the units of length (m):

$$\begin{aligned}
 F(L, B, W) = & \left(2 + \frac{L+B}{W}\right) [(L+W)^2 + (B+W)^2]^{1/2} \\
 & - \sqrt{2} \left(1 + \frac{L}{2W}\right) [L^2 + (L+2W)^2]^{1/2} \\
 & - \sqrt{2} \left(1 + \frac{B}{2W}\right) [B^2 + (B+2W)^2]^{1/2} - \left(\frac{L+B}{W}\right) (L^2 + B^2)^{1/2} \\
 & + \left(\frac{L^2 + B^2}{W}\right) [1 + \sqrt{2} \ln(\sqrt{2} - 1)] + 2W [\sqrt{2} + \ln(\sqrt{2} - 1)] \\
 & - \frac{\sqrt{2}G^2}{W} \ln \left\{ \frac{[G^2 + (D+2W)^2]^{1/2} + D + 2W}{(G^2 + D^2)^{1/2} + D} \right\} \\
 & + \left[ \frac{G^2 - (B+W)^2}{W} \right] \times \ln \left\{ \frac{[(L+W)^2 + (B+W)^2]^{1/2} + B + W}{L + W} \right\} \\
 & + \left[ \frac{G^2 - (L+W)^2}{W} \right] \times \ln \left\{ \frac{[(L+W)^2 + (B+W)^2]^{1/2} + L + W}{B + W} \right\} \\
 & + \left[ \frac{L(2B-L)}{W} \right] \ln \left\{ \frac{(L^2 + B^2)^{1/2} + B}{L} \right\} \\
 & + \left[ \frac{B(2L-B)}{W} \right] \ln \left\{ \frac{(L^2 + B^2)^{1/2} + L}{B} \right\} \\
 & - \left( \frac{L^2 - W^2}{W} \right) \ln \left\{ \frac{[W^2 + (L+W)^2]^{1/2} + W}{L + W} \right\} \\
 & - \left( \frac{B^2 - W^2}{W} \right) \ln \left\{ \frac{[W^2 + (B+W)^2]^{1/2} + W}{B + W} \right\} \\
 & + (2L + W) \ln \left\{ \frac{[W^2 + (L+W)^2]^{1/2} + L + W}{W} \right\} \\
 & + (2B + W) \ln \left\{ \frac{[W^2 + (B+W)^2]^{1/2} + B + W}{W} \right\} \\
 & + \frac{\sqrt{2}L^2}{W} \ln \left\{ \frac{[L^2 + (L+2W)^2]^{1/2} + L + 2W}{L} \right\} \\
 & + \frac{\sqrt{2}B^2}{W} \ln \left\{ \frac{[B^2 + (B+2W)^2]^{1/2} + B + 2W}{B} \right\}
 \end{aligned} \tag{B11-2}$$

where  $G = L - B,$  and  $D = L + B.$

**B11.2.2 Development of Comparative Example Results, Ground-Coupled Slab Cases.** Table B11-4 describes the

models used to generate the example results for the test cases of Section 5.2.4 (see Annex B8, Section B8.2).

**B11.2.2.1 Selection of Programs.** The selection criteria for programs used for producing example results per Section 5.2.4 were more extensive than required elsewhere in this standard. For the numerical models used to develop the verified numerical model results, the selection criteria required the following:

- a. 3D modeling
- b. Ability to model all boundary conditions of Case GC10a, for true analytical verification
- c. Adjustable node meshing
- d. Adjustable duration of simulation (e.g., more than five years)
- e. Adjustable convergence tolerance, where applicable
- f. Adjustable ground depth and far-field dimensions
- g. Calculative time increments of one hour or less
- h. Meeting quasi-analytical solution definitional requirements
  1. Calculations occur outside the environment of a whole-building energy simulation program (i.e., a means to run the slab/ground model by itself without interacting with additional calculation routines of a larger whole-building simulation)
  2. Ability to scrutinize calculations (supporting input files and detailed modeler reports provided).

For the mid-level-detailed models, the selection criteria required the following:

- a. The whole-building simulation program platform be a true simulation based on hourly weather data and calculative time increments of 1 hour or less and be representative of the state-of-the-art in whole-building energy simulation as defined by the country making the selection.
- b. The mid-level-detailed ground heat transfer model used by the whole-building simulation platform be representative of the state-of-the-art as defined by the country making the selection.

**B11.2.2.2 Modeling Rules for Generating Example Results.** The modeling rules were somewhat more stringent for the simulation programs used for the example results of Annex B8, Section B8.2 than for a given program to be normally tested with this BESTEST suite. For the Annex B8, Section B8.2 simulation results, a variety of modeling approaches were allowed. However, the cases were required to be modeled in the most detailed way possible for each simulation program. Whenever possible with all ground-coupled heat transfer models (required for verified numerical models), demonstrate that modeling is at a level of detail where including further detail yields negligible sensitivity (0.1% or lower) to results versus the previous level of detail. Sensitivity tests, when possible (required for verified numerical models), were recommended to cover at least the following aspects of the models: node mesh detail, simulation duration (for non-steady-state cases or when dynamic models are applied to steady-state cases), convergence tolerance (when applicable), and

**TABLE B11-4 Ground-Coupled Slab-On-Grade Analytical Verification—Participating Organizations and Models**

<b>Analytical Solution, Case GC10a</b>	<b>Authoring Organization</b>	<b>Implemented by</b>
Delsante, Stokes, and Walsh (1983) <sup>A-4</sup>	Commonwealth Scientific and Industrial Research Organisation, Australia	NREL/JNA, <sup>a,b</sup> United States
<b>Verified Numerical Model</b>	<b>Authoring Organization</b>	<b>Implemented by</b>
FLUENT 6.0.20	Fluent, Incorporated, United States	PAAET, <sup>c</sup> Kuwait
MATLAB 7.0.4.365 (R14)	The MathWorks, Inc., United States	Dublin Institute of Technology, Ireland
TRNSYS 16.1	University of Wisconsin/TESS, <sup>d</sup> United States	TESS, <sup>d</sup> United States
<b>Simulation Program</b>	<b>Authoring Organization</b>	<b>Implemented by</b>
BASECALC V1.0e	CETC, <sup>e</sup> Canada	CETC, <sup>e</sup> Canada
EnergyPlus 2.0.0.025	LBNL/UIUC/DOE-BT, <sup>f,g,h</sup> United States	GARD Analytics, Inc., United States
ESP-r/BASESIMP	CETC/ESRU, <sup>e,i</sup> Canada/United Kingdom	CETC, <sup>e</sup> Canada
GHT	NREL, <sup>a</sup> United States	NREL, <sup>a</sup> United States
SUNREL-GC 1.14.01	NREL, <sup>a</sup> United States	NREL, <sup>a</sup> United States
VA114 2.20/ISO-13370	VABI Software BV, The Netherlands; CEN/ISO <sup>j,k</sup>	VABI Software BV, The Netherlands

a. NREL: National Renewable Energy Laboratory, United States

b. JNA: J. Neymark & Associates, United States

c. PAAET: Public Authority for Applied Education and Training, Kuwait

d. TESS: Thermal Energy Systems Specialists, United States

e. CETC: CANMET Energy Technology Centre, Natural Resources Canada, Canada

f. LBNL: Lawrence Berkeley National Laboratory, United States

g. UIUC: University of Illinois Urbana/Champaign, United States

h. DOE-BT: U.S. Department of Energy, Office of Building Technologies, Energy Efficiency and Renewable Energy, United States

i. ESRU: Energy Systems Research Unit, University of Strathclyde, United Kingdom

j. CEN: European Committee for Standardization, Belgium

k. ISO: International Organization for Standardization, Switzerland

amount of ground modeled (for Case GC10a only). Such sensitivity tests were allowed to be performed for a subset of the test cases if the modeler could logically demonstrate that the appropriate level of detail identified for a given case (e.g., GC40a or GC40b) was appropriate for other cases (GC70b, etc.).

*All references listed below are cited in new addendum language (some of these may be already cited in 140-2011).*

## INFORMATIVE ANNEX B24 INFORMATIVE REFERENCES

- <sup>A-1</sup> ASHRAE. 2005. *ASHRAE Handbook—Fundamentals*. Atlanta: ASHRAE.
- <sup>A-2</sup> ASHRAE. 2001. *ASHRAE Handbook—Fundamentals*. Atlanta: ASHRAE
- <sup>A-3</sup> Brandemuehl, M. 1993. *HVAC 2 Toolkit: A Toolkit for Secondary HVAC System Energy Calculations*. Atlanta: ASHRAE. (See p. 7-15.)
- <sup>A-4</sup> Delsante, A.E., Stokes, A.N., and Walsh, P.J. 1983. Application of Fourier Transforms to Periodic Heat Flow into the Ground under a Building. *International Journal of Heat Mass Transfer* 26(1):121-32.
- <sup>A-5</sup> Judkoff, R., and Neymark, J. 1995. *International Energy Agency Building Energy Simulation Test (BESTEST) and*

*Diagnostic Method*. NREL/TP-472-6231, Golden, Colorado: National Renewable Energy Laboratory. [www.nrel.gov/docs/legosti/old/6231.pdf](http://www.nrel.gov/docs/legosti/old/6231.pdf). (See Appendix D.)

- <sup>A-7</sup> Neymark, J., and R. Judkoff, with I. Beausoleil-Morrison, A. Ben-Nakhi, M. Crowley, M. Deru, R. Henninger, H. Ribberink, J. Thornton, A. Wijsman, and M. Witte. 2008. *International Energy Agency Building Energy Simulation Test and Diagnostic Method (IEA BESTEST) In-Depth Diagnostic Cases for Ground Coupled Heat Transfer Related to Slab-On-Grade Construction*. NREL/TP-550-43388. Golden, CO: National Renewable Energy Laboratory. In collaboration with International Energy Agency Solar Heating and Cooling Program Task 34 and Energy Conservation in Buildings and Community Systems Annex 43. <http://www.nrel.gov/docs/fy08osti/43388.pdf>.
- <sup>A-8</sup> Spitler, J.D.; Rees, S.J.; Xiao, D. 2001. *Development of an Analytical Verification Test Suite for Whole Building Energy Simulation Programs—Building Fabric*. Final Report for ASHRAE 1052-RP. Atlanta: ASHRAE.
- <sup>A-9</sup> Walton, G. 1983. *Thermal Analysis Research Program Reference Manual (TARP)*. NBSIR 83-2655. Washington, D.C.: National Bureau of Standards (now called National Institute of Standards and Technology).



## **POLICY STATEMENT DEFINING ASHRAE'S CONCERN FOR THE ENVIRONMENTAL IMPACT OF ITS ACTIVITIES**

ASHRAE is concerned with the impact of its members' activities on both the indoor and outdoor environment. ASHRAE's members will strive to minimize any possible deleterious effect on the indoor and outdoor environment of the systems and components in their responsibility while maximizing the beneficial effects these systems provide, consistent with accepted standards and the practical state of the art.

ASHRAE's short-range goal is to ensure that the systems and components within its scope do not impact the indoor and outdoor environment to a greater extent than specified by the standards and guidelines as established by itself and other responsible bodies.

As an ongoing goal, ASHRAE will, through its Standards Committee and extensive technical committee structure, continue to generate up-to-date standards and guidelines where appropriate and adopt, recommend, and promote those new and revised standards developed by other responsible organizations.

Through its *Handbook*, appropriate chapters will contain up-to-date standards and design considerations as the material is systematically revised.

ASHRAE will take the lead with respect to dissemination of environmental information of its primary interest and will seek out and disseminate information from other responsible organizations that is pertinent, as guides to updating standards and guidelines.

The effects of the design and selection of equipment and systems will be considered within the scope of the system's intended use and expected misuse. The disposal of hazardous materials, if any, will also be considered.

ASHRAE's primary concern for environmental impact will be at the site where equipment within ASHRAE's scope operates. However, energy source selection and the possible environmental impact due to the energy source and energy transportation will be considered where possible. Recommendations concerning energy source selection should be made by its members.

